

Since 1898
CONSEW[®]

— CONSOLIDATED SEWING MACHINE CORP.

PARTS MANUAL FOR Models 697VF / 697BVF

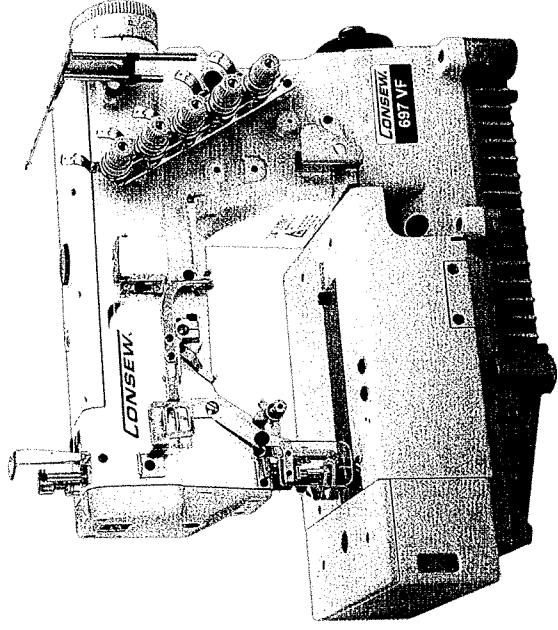

**HIGH SPEED, FLAT BED, TOP & BOTTOM
COVERSTITCH MACHINES**

Specifications subject to change without notice.

From the library of: **Diamond Needle Corp**

©2004 Consew -204- Printed in USA

inside of cover



INSTRUCTION BOOK FOR Models 697VF / 697BVF

TABLE OF CONTENTS

	PAGE
A.--(1) MISCELLANEOUS COVERS(1) -----	2-3
B.--(2) MISCELLANEOUS COVERS(2) -----	4-5
C.----- MISCELLANEOUS THREAD EYELETS -----	6-7
D.----- MISCELLANEOUS BUSHINGS -----	8-9
E.----- MAIN SHAFT DRIVING MECHANISM -----	10-11
F.----- THREAD TAKE-UP MECHANISM -----	12-13
G.----- UPPER SHAFT MECHANISM -----	14-15
H.----- NEEDLE THREAD TAKE-UP MECHANISM -----	16-17
I.----- NEEDLE BAR MECHANISM -----	18-19
J.----- PRESSER FOOT MECHANISM -----	20-21
K.----- SPREADER MECHANISM -----	22-23
L.--(1) LOOPER DRIVING MECHANISM(1) -----	24-25
M.--(2) LOOPER DRIVING MECHANISM(2) -----	26-27
N.----- FEED DRIVING CONTROL MECHANISM -----	28-29
O.----- FEED DRIVING MECHANISM -----	30-31
P.----- LUBRICATING SYSTEM -----	32-33
R.----- ACCESSORIES -----	34-35
NUMERICAL PARTS-LIST -----	36-39
ALTERNATIVE PARTS APPENDIX -----	40

A. MISCELLANEOUS COVERS(1)

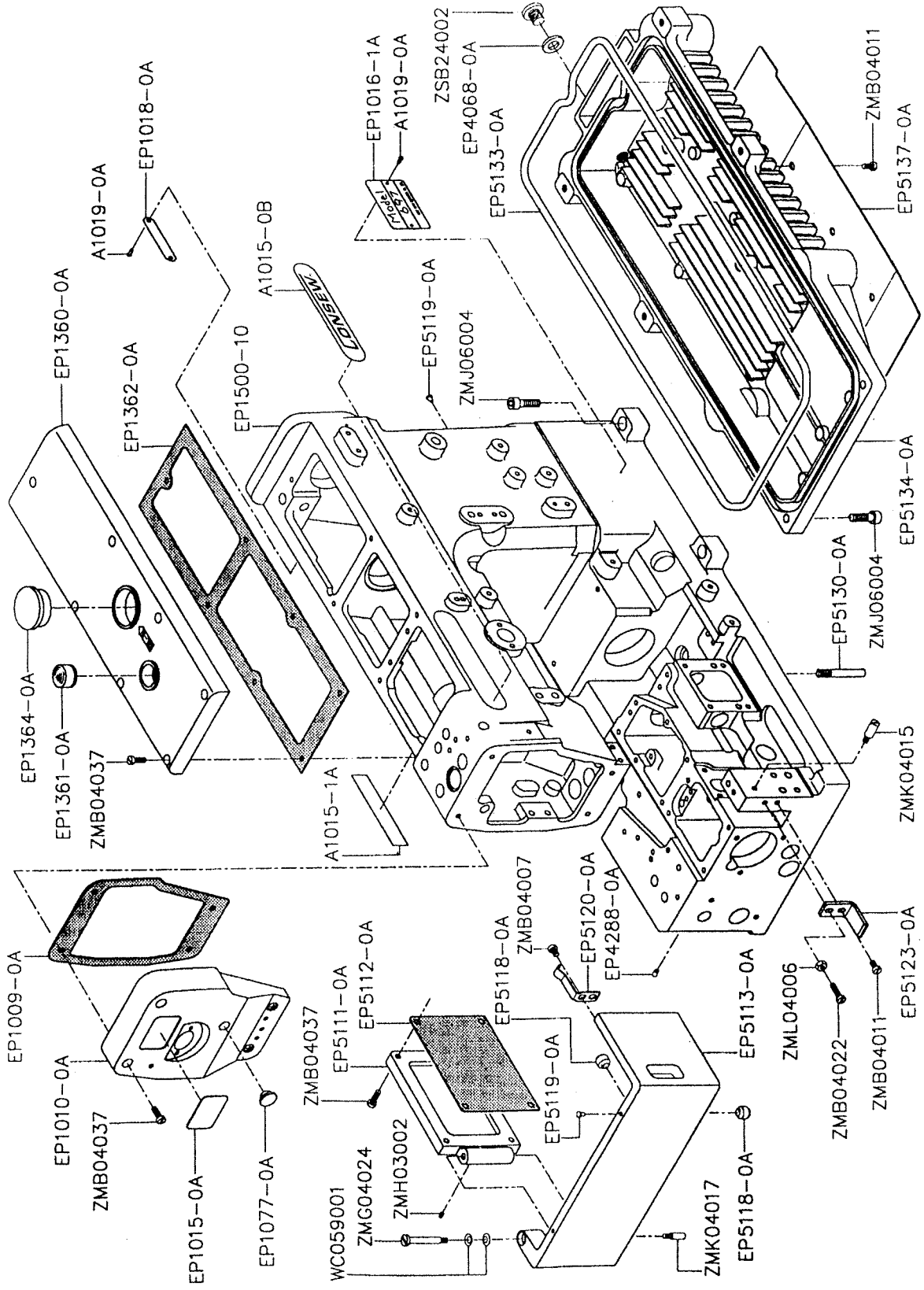

A. MISCELLANEOUS COVERS(1)

Parts No.	Name of Parts	Q'TY
A1015-0B	Name Plate	1
A1015-1A	Name Plate	1
A1019-0A	Rivet	4
EP1009-0A	Head Cover Gasket	1
EP1010-0A	Head Cover	1
EP1015-0A	Name Plate	1
EP1016-1A	Model Plate	1
EP1018-0A	Serial Number Plate	1
EP1077-0A	Head Cover Seal Plug	1
EP1360-0A	Top cover	1
EP1361-0A	Oil Sight Window	1
EP1362-0A	Top cover Gasket	1
EP1364-0A	Top Cover Seal Plug	1
EP1500-10	Machine Frame Unit	1
EP4068-0A	Drain Hole Seal	1
EP4288-0A	Seal Plug	1
EP5111-0A	Bed Rear Cover	1
EP5112-0A	Bed Rear Cover Gasket	1
EP5113-0A	Side Cover	1
EP5118-0A	Rubber Cushion (Large)	2
EP5119-0A	Rubber Cushion (Small)	3
EP5120-0A	Cover Latch Spring	1
EP5123-0A	Side Cover Holder	1
EP5130-0A	Machine Frame Supporting Bar	4
EP5133-0A	Oil Reservoir Gasket	1
EP5134-0A	Oil Reservoir	1
EP5137-0A	Wind Guide Plate	1
WC059001	Conical Spring Washer	2
ZMB04007	Screw (M4-0.7×5)	2
ZMB04011	Screw (M4-0.7×8)	5
ZMB04022	Screw (M4-0.7×15)	1
ZMB04037	Screw (M4-0.7×12)	15
ZMG04024	Screw (M4-0.7×8)	1
ZMH03002	Screw (M3-0.5×3)	1
ZMJ06004	Screw (M6-1×20)	6
ZMK04015	Screw (M4-0.7×7)	1
ZMK04017	Screw (M4-0.7×6)	1
ZML04006	Nut (M4-0.7)	1
ZSB24002	Screw (3/8-28×8)	1

B. MISCELLANEOUS COVERS(2)

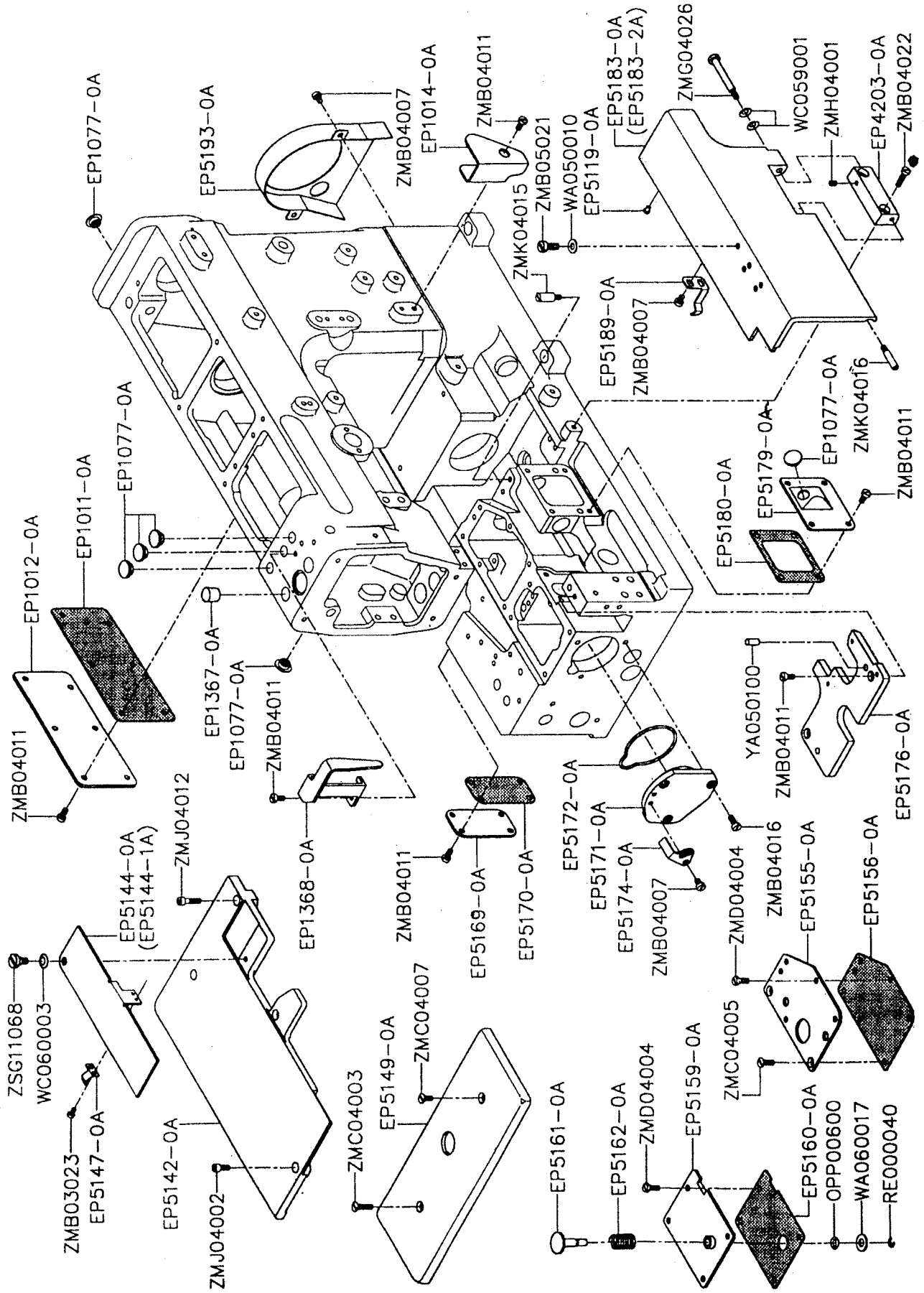

B. MISCELLANEOUS COVERS(2)

Parts No.	Name of Parts	Q'TY	Parts No.	Name of Parts	Q'TY
EP1011-0A	Rear Cover Gasket	1	OPP00600	O-ring (P6)	1
EP1012-0A	Rear Cover	1	RE000040	Retaining Ring	1
EP1014-0A	Eyelet Cover	1	WA050010	Washer	2
EP1077-0A	Seal Plug	6	WA060017	Washer	1
EP1367-0A	Seal Plug	1	WC059001	Conical Spring Washer	2
EP1368-0A	Needle Bar Guard	1	WC060003	Conical Spring Washer	1
EP4203-0A	Front Cover Hinge	1	YA050100	Knock Pin	2
EP5119-0A	Rubber Cushion (Small)	2	ZMB03023	Screw (M3-0.5x2.6)	2
EP5142-0A	Cloth Plate (Large)	1	ZMB04007	Screw (M4-0.7x5)	6
EP5144-0A	Looper Thread Take-up Cover (32, 40, 48, 56)	1	ZMB04011	Screw (M4-0.7x8)	19
EP5144-1A	Looper Thread Take-up Cover (64)	1	ZMB04016	Screw (M4-0.7x10)	3
EP5147-0A	Take-up Cover Spring	1	ZMB04022	Screw (M4-0.7x15)	2
EP5149-0A	Cloth Plate (Small)	1	ZMB05021	Screw (M5-0.8x12)	2
EP5155-0A	Bed Top Cover (Right)	1	ZMC04003	Screw (M4-0.7x14)	1
EP5156-0A	Bed Top Cover Gasket (Right)	1	ZMC04005	Screw (M4-0.7x10)	2
EP5159-0A	Bed Top Cover (Left)	1	ZMC04007	Screw (M4-0.7x7)	1
EP5160-0A	Bed Top Cover Gasket (Left)	1	ZMD04004	Screw (M4-0.7x10)	8
EP5161-0A	Feed Regulating Pushbutton	1	ZMG04026	Screw (M4-0.7x8)	1
EP5162-0A	Feed Regulating Pushbutton Spring	1	ZMH04001	Screw (M4-0.7x4)	1
EP5169-0A	Bed Rear Cover (Small)	1	ZMJ04002	Screw (M4-0.7x10)	1
EP5170-0A	Bed Rear Cover Gasket (Small)	1	ZMJ04012	Screw (M4-0.7x16)	3
EP5171-0A	Ball Bearing Housing	1	ZMK04015	Screw (M4-0.7x7)	1
EP5172-0A	O-ring	1	ZMK04016	Screw (M4-0.7x6)	1
EP5174-0A	Pushbutton Stop	1	ZSG11068	Screw (11/64-40x6.7)	1
EP5176-0A	Stitch Plate Support	1			
EP5179-0A	Bed Front Cover	1			
EP5180-0A	Bed Front Cover Gasket	1			
EP5183-0A	Front Cover (32, 40, 48, 56)	1			
EP5183-2A	Front Cover (64)	1			
EP5189-0A	Front Cover Spring	1			
EP5193-0A	Oil Cooling Fan Cover	1			

C. MISCELLANEOUS THREAD EYELETS

Parts No.	Name of Parts	Q'TY	Parts No.	Name of Parts	Q'TY
EP1021-0A	Needle Thread Tension Spring	3	EP1063-0A	SP Container	1
EP1021-1A	Top Cover Thread Tension Spring	1	EP1064-0A	SP Felt Stay	1
EP1021-2A	Looper Thread Tension Spring	1	EP1067-0A	Top Cover Thread Eyelet (Right)	1
EP1024-0A	Tension Disc Eyelet	5	EP1073-0A	Top Cover Thread Eyelet (Left)	1
EP1024-1A	Thread Lead-in Guide	5	EP5215-0A	Looper Thread Eyelet	1
EP1025-0A	Tension Disc	10	EP5218-0A	Looper Thread Eyelet	1
EP1026-0A	Tension Post	5	WA030006	Washer	2
EP1027-0A	Needle Thread Guide	1	WA049006	Washer	4
EP1029-0A	Tension Post Ferrule	5	XB123001	Felt	5
EP1030-0A	Thread Tension Spring Retainer	5	XB310005	Felt	1
EP1031-0A	Tension Disc Separator	1	XC200060	Felt	1
EP1032-0A	Tension Post Support	1	YD020006	Pin	2
EP1034-0A	Thread Tension Spring Cap	5	YD040008	Guide Pin	1
EP1035-0A	Supplementary Tension Disc	2	ZMB04011	Screw (M4-0.7x8)	14
EP1036-0A	Supplementary Tension Spring	1	ZMC03004	Screw (M3-0.5x8)	2
EP1037-0A	Tension Post	1	ZMC04007	Screw (M4-0.7x8)	1
EP1038-0A	Supplementary Thread Guide	1	ZSB09017	Screw (9/64-40x7)	2
EP1039-1A	Top Cover Thread Guide	1	ZSG08006	Screw (1/8-44x2.2)	1
EP1041-0A	Thread Retainer Disc Support	1	ZSN11002	Nut	1
EP1042-0A	Needle Thread Retainer Disc	1			
EP1043-0A	Needle Thread Retainer Spring	1			
EP1045-0A	Needle Thread Retainer Support	1			
EP1047-0A	Looper Thread Eyelet (Long)	1			
EP1051-0A	Needle Thread Take-up Guard	1			
EP1056-0A	Thread Eyelet Pipe (Short)	2			
EP1057-0A	Thread Eyelet Pipe Stay	2			
EP1058-0A	Thread Guide Plate	1			
EP1059-0A	Thread Guide, Complete Set	1			
EP1060-0A	SP Device, Complete Set	1			
EP1061-0A	Needle Thread Eyelet	1			
EP1062-0A	SP Container Lid	1			

D. MISCELLANEOUS BUSHINGS

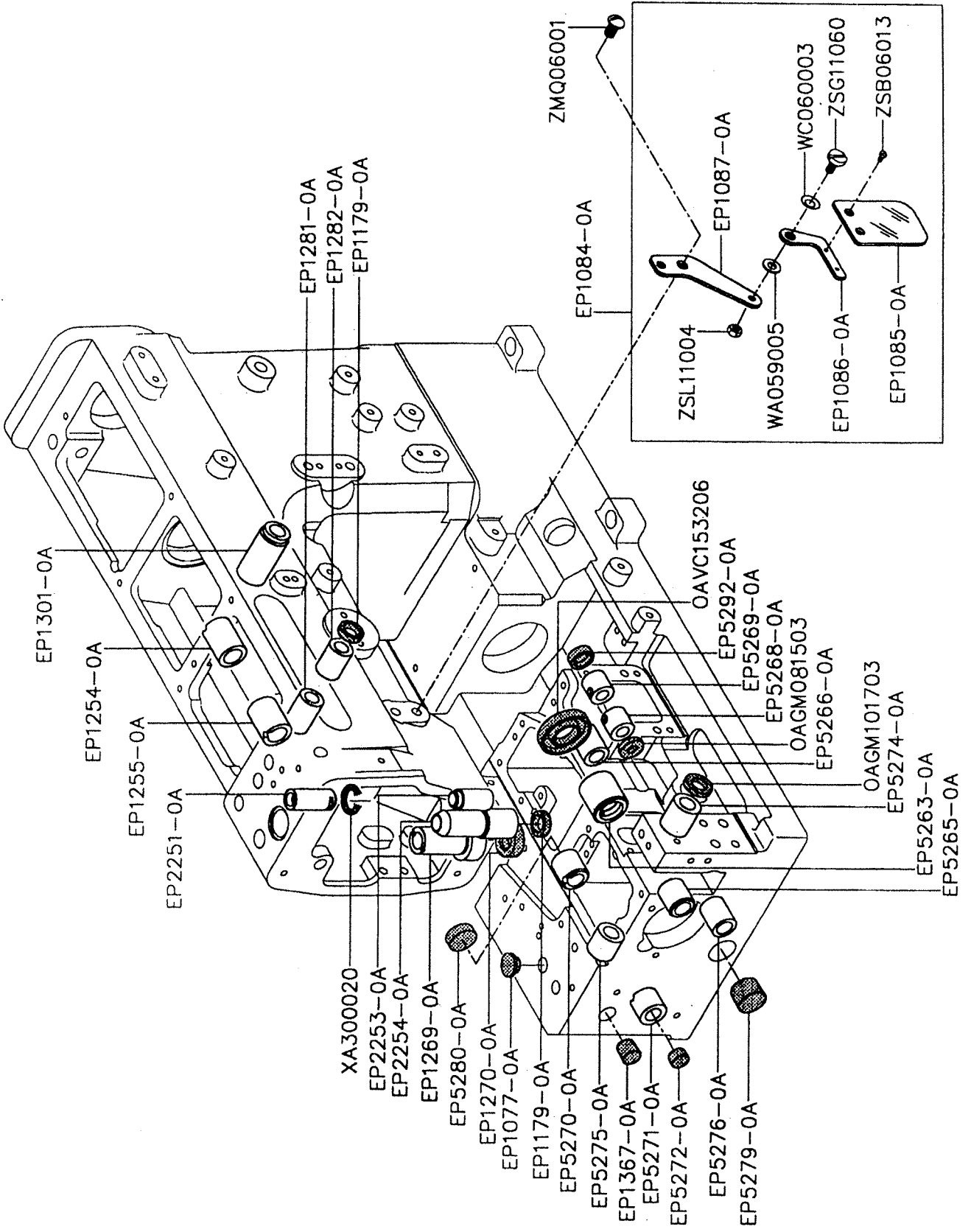

D. MISCELLANEOUS BUSHINGS

Parts No.	Name of Parts	Q'TY	Parts No.	Name of Parts	Q'TY
EP1077-0A	Seal Plug	1	OAGM081503	Seal Plug	1
EP1084-0A	Eye Guard, Complete Set	1	OAGM101703	Seal Plug	1
EP1085-0A	Eye Guard	1	OAVC153206	Seal Plug	1
EP1086-0A	Eye Guard Holder	1	WA059005	Washer	1
EP1087-0A	Eye Guard Support	1	WC060003	Conical Spring Washer	1
EP1179-0A	Oil Seal	2	XA300020	Oil Wick	1
EP1254-0A	Spreader Driving Shaft Bushing (Right)	1	ZM006001	Screw (M6-1×10)	1
EP1255-0A	Spreader Driving Shaft Bushing (Left)	1	ZSB06013	Screw (3/32-56×4.2)	2
EP1269-0A	Spreader Driving Bar Bushing	1	ZSG11060	Screw (11/64-40×9.7)	1
EP1270-0A	Oil Seal	1	ZSL11004	Nut (11/64-40)	1
EP1281-0A	Needle Thread Take-up Bushing (Rear)	1			
EP1282-0A	Needle Thread Take-up Bushing (Front)	1			
EP1301-0A	Foot Lifter Lever Bushing	1			
EP1367-0A	Seal Plug	1			
EP2251-0A	Needle Bar Bushing (Upper)	1			
EP2253-0A	Needle Bar Bushing (Lower)	1			
EP2254-0A	Presser Bar Bushing	1			
EP2263-0A	Lower Shaft Bushing (Left)	1			
EP2265-0A	Looper Rocker Shaft Bushing (Left)	1			
EP2266-0A	Looper Rocker Shaft Bushing (Right)	1			
EP2268-0A	Needle Guard Shaft Bushing (Left)	1			
EP2269-0A	Needle Guard Shaft Bushing (Right)	1			
EP5270-0A	Feed Bar Driving Shaft Bushing (Right)	1			
EP5271-0A	Feed Bar Driving Shaft Bushing (Left)	1			
EP5272-0A	Seal Plug	1			
EP5274-0A	Looper Driving Shaft Bushing (Front)	1			
EP5275-0A	Looper Driving Shaft Bushing (Rear)	1			
EP5276-0A	Differential Lever Bushing	1			
EP5279-0A	Seal Plug	1			
EP5280-0A	Seal Plug	1			
EP5292-0A	Seal Plug	1			

E. MAIN SHAFT DRIVING MECHANISM

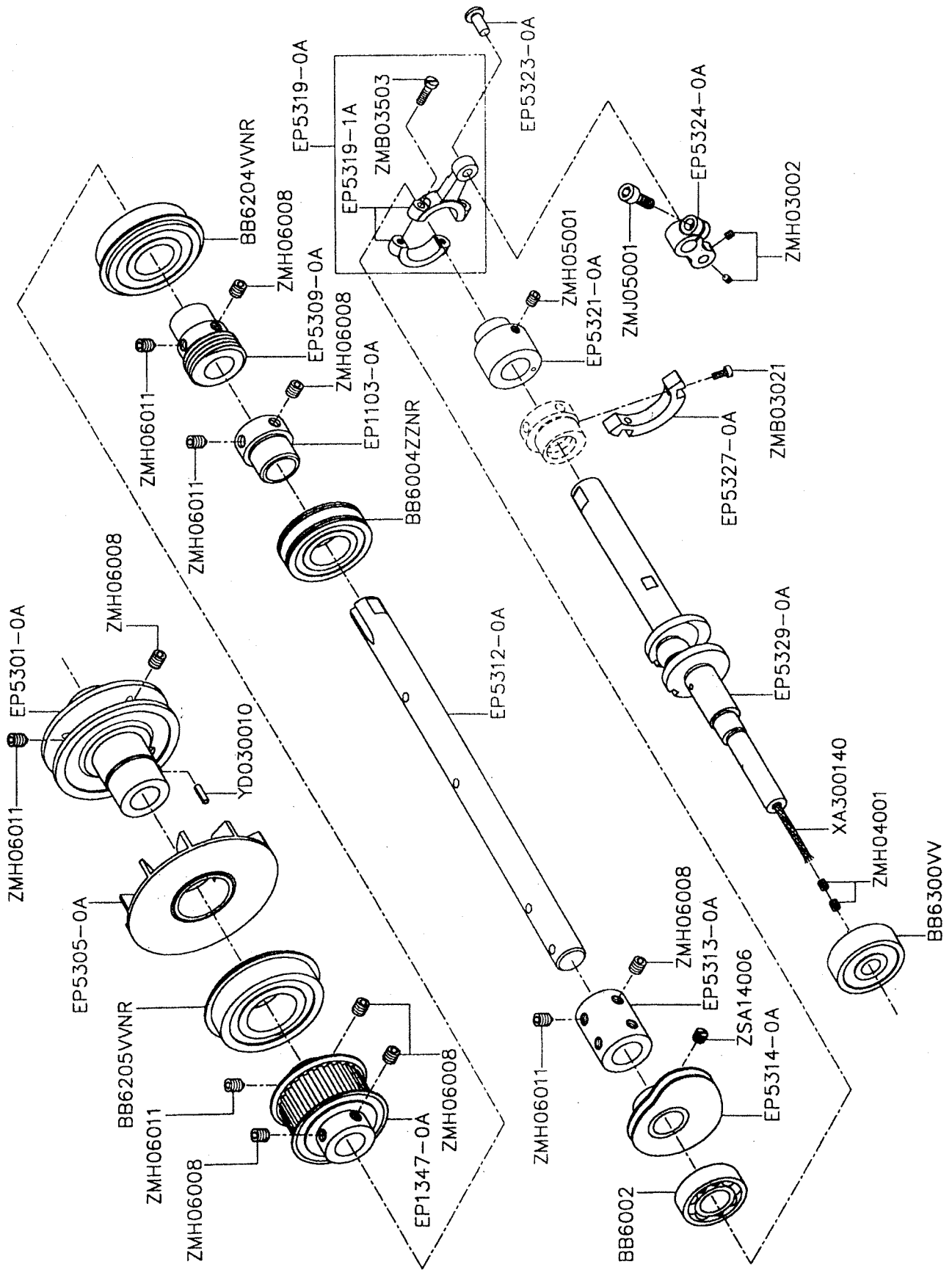

E. MAIN SHAFT DRIVING MECHANISM

Parts No.	Name of Parts	Q'TY
BB6002	Ball Bearing	1
BB6004ZZNR	Ball Bearing (Left)	1
BB6204VNR	Ball Bearing (Middle)	1
BB6205VNR	Ball Bearing (Right)	1
BB6300VV	Ball Bearing	1
EP1103-0A	Adapter	1
EP1347-0A	Main Shaft Pulley (Lower)	1
EP5301-0A	Pulley	1
EP5305-0A	Oil Cooling Fan	1
EP5309-0A	Oil Pump Driving Worm	1
EP5312-0A	Lower Shaft (Right)	1
EP5313-0A	Lower Shaft Joint	1
EP5314-0A	Lower Thread Take-up	1
EP5319-0A	Needle Guard Connecting Rod, C. Set	1
EP5319-1A	Needle Guard Connecting Rod	1
EP5321-0A	Needle Guard Eccentric	1
EP5323-0A	Connecting Rod Pin	1
EP5324-0A	Needle Guard Driving Shaft Arm	1
EP5327-0A	counterweight	1
EP5329-0A	Lower Crankshaft	1
XA300140	Oil Wick	1
YD030010	Roll Pin	1
ZMB03021	Screw (M3-0.5×6.5)	2
ZMB03503	Screw (M3.5-0.6×12)	2
ZMH03002	Screw (M3-0.5×8)	2
ZMH04001	Screw (M4-0.7×4)	2
ZMH05001	Screw (M5-0.8×5)	2
ZMH06008	Screw (M6-1×8)	9
ZMH06011	Screw (M6-1×6)	5
ZMJ05001	Screw (M5-0.8×14)	1
ZSA14006	Screw (7/32-32×3.6)	2

F. THREAD TAKE-UP MECHANISM

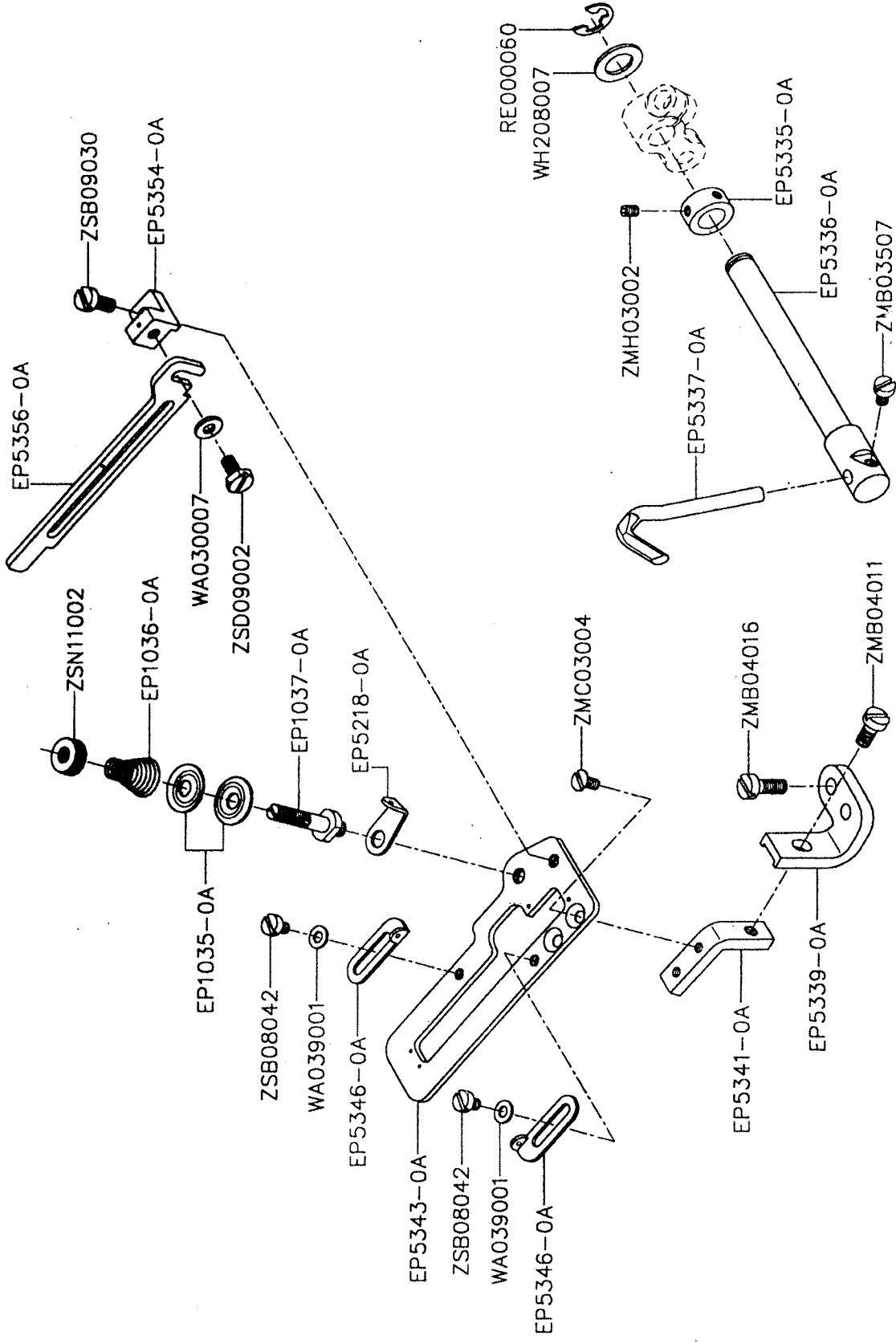

F. THREAD TAKE-UP MECHANISM

Parts No.	Name of Parts	Q'TY
EP1035-0A	Supplementary Tension Disc	2
EP1036-0A	Supplementary Tension Spring	1
EP1037-0A	Tension Post	1
EP5218-0A	Looper Thread Eyelet	1
EP5335-0A	Collar	1
EP5336-0A	Needle Guard Driving Shaft	1
EP5337-0A	Needle Guard (Rear)	1
EP5339-0A	Supporting Plate Stay (Lower)	1
EP5341-0A	Supporting Plate Stay (Upper)	1
EP5343-0A	Supporting Plate	1
EP5346-0A	Thread Take-up Eyelet	2
EP5354-0A	Cast-off Plate Bracket	1
EP5356-0A	Cast-off Plate	1
RE000060	Retaining Ring	1
WA030007	Washer	1
WA039001	Washer	2
WH208007	Washer	1
ZMB03507	Screw (M3.5-0.6×4.5)	1
ZMB04011	Screw (M4-0.7×8)	1
ZMB04016	Screw (M4-0.7×10)	2
ZMC03004	Screw (M3-0.5×6)	2
ZMH03002	Screw (M3-0.5×3)	2
ZSB08042	Screw (1/8-44×3.8)	2
ZSB09030	Screw (9/64-40×7.5)	1
ZSD09002	Screw (9/64-40×6.5)	1
ZSN11002	Adjusting Nut	1

G. UPPER SHAFT MECHANISM

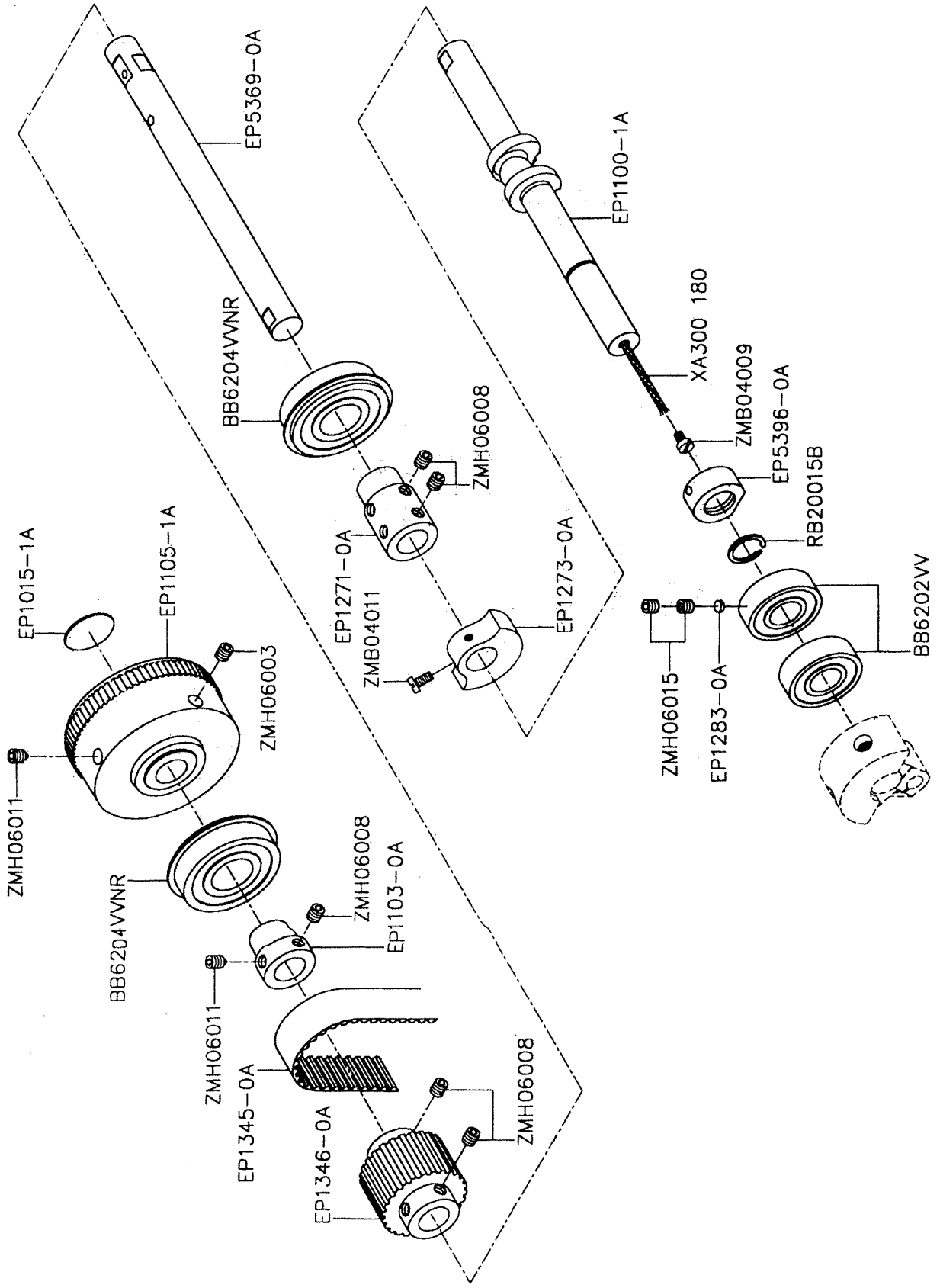

G. UPPER SHAFT MECHANISM

Parts No.	Name of Parts	Q'TY
BB6202W	Ball Bearing -----	2
BB6204VNR	Ball Bearing -----	2
EP1015-1A	Handwheel Mark -----	1
EP1100-1A	Upper Crankshaft -----	1
EP1103-0A	Handwheel Adapter -----	1
EP1105-1A	Handwheel -----	1
EP1271-0A	Upper Shaft Joint -----	1
EP1273-0A	counterweight (Small) -	1
EP1283-0A	Rubber Seat -----	1
EP1345-0A	Timing Belt -----	1
EP1346-0A	Upper Shaft Pulley -----	1
EP5369-0A	Upper Shaft (Right) ---	1
EP5396-0A	Oil Sleeve -----	1
RB20015B	Retaining Ring -----	1
XA300 180	Oil Wick -----	1
ZMB04009	Screw (M4-0.7×6) -----	1
ZMB04011	Screw (M4-0.7×8) -----	2
ZMH06003	Screw (M6-1×8) -----	1
ZMH06008	Screw (M6-1×6) -----	9
ZMH06011	Screw (M6-1×8) -----	2
ZMH06015	Screw (M6-1×4.8) -----	2

H. NEEDLE THREAD TAKE-UP MECHANISM

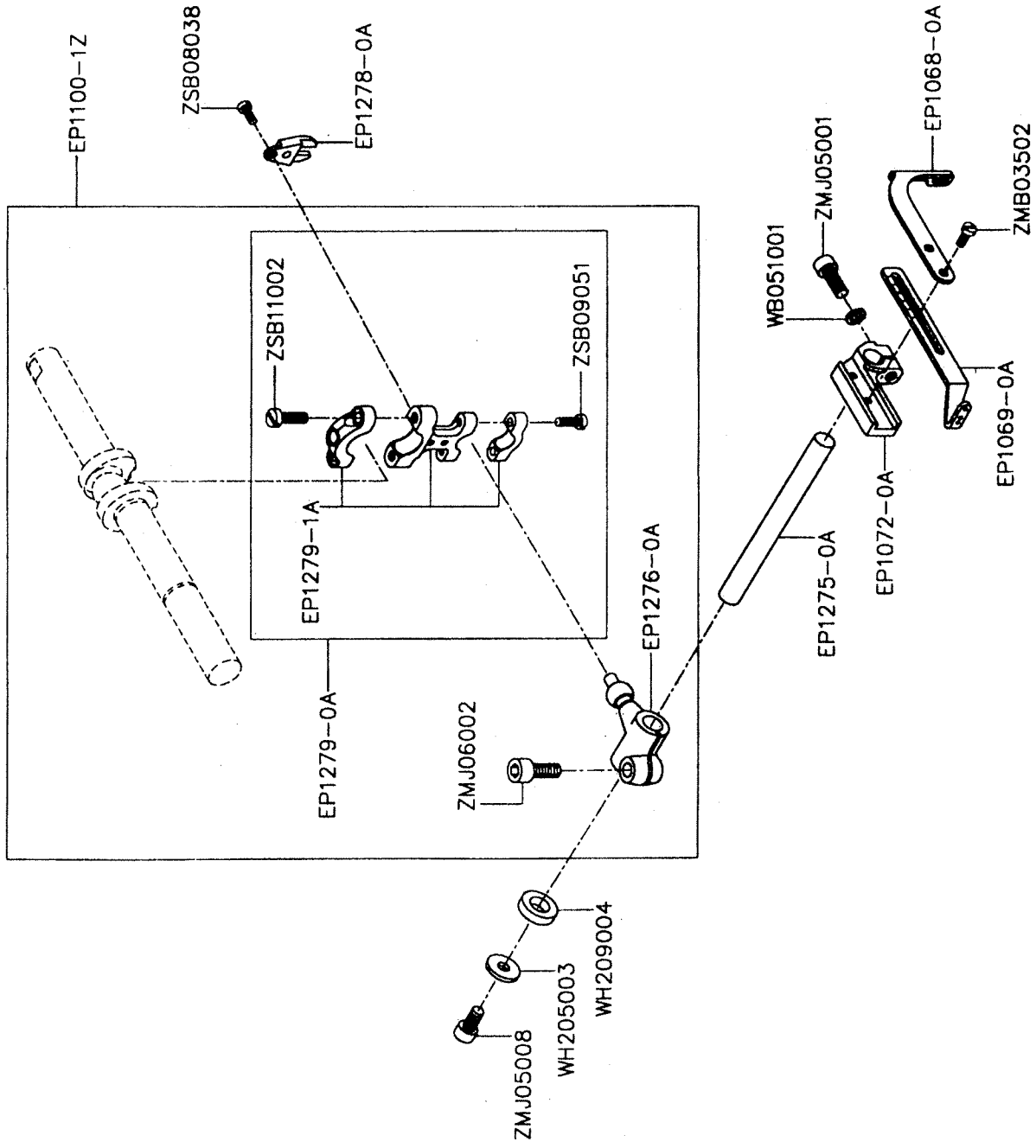

H. NEEDLE THREAD TAKE-UP MECHANISM

Parts No.	Name of Parts	Q'TY
EP1068-0A	Top Cover Thread Take-up	1
EP1069-0A	Needle Thread Take-up	1
EP1072-0A	Bracket	1
EP1100-1Z	Upper Crankshaft, Complete Set	1
EP1275-0A	Driving Shaft	1
EP1276-0A	Driving Lever	1
EP1278-0A	Guide Fork	1
EP1279-0A	Connecting Rod, Complete Set	1
EP1279-1A	Connecting Rod	1
WB051001	Spring Washer	1
WH205003	Washer	1
WH209004	Spacer	1
ZMB03502	Screw (M3.5-0.6×8)	2
ZMJ05001	Screw (M5-0.8×14)	1
ZMJ05008	Screw (M5-0.8×10)	1
ZMJ06002	Screw (M6-1×15)	1
ZSB08038	Screw (1/8-44×7.9)	2
ZSB09051	Screw (9/64-40×10.3)	2
ZSB11002	Screw (11/64-40×14)	2

I. NEEDLE BAR MECHANISM

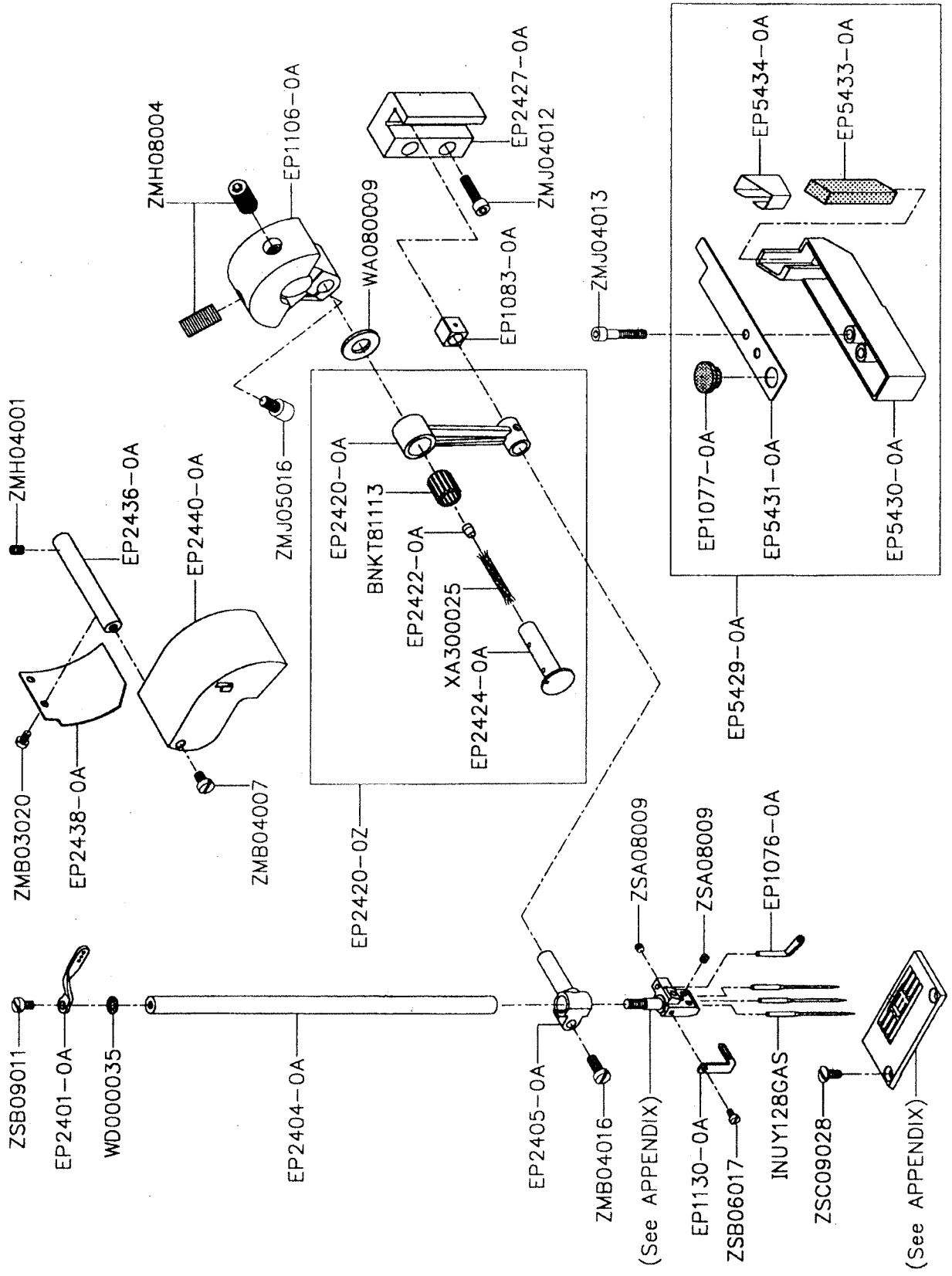

I. NEEDLE BAR MECHANISM

Parts No.	Name of Parts	Q'TY	Parts No.	Name of Parts	Q'TY
BNKT81113	Roller Bearing	1	ZMJ04012	Screw (M4-0.7×16)	2
EP1076-0A	Top Cover Thread Eyelet	1	ZMJ04013	Screw (M4-0.7×20)	2
EP1077-0A	Seal Plug	1	ZMJ05016	Screw (M5-0.8×10)	1
EP1083-0A	Slide Block	1	ZSA08009	Screw (1/8-44×2.4)	4
EP1106-0A	Counterweight	1	ZSB06017	Screw (3/32-56×4)	1
EP1130-0A	Needle Thread Eyelet	1	ZSB09011	Screw (9/64-40×5.6)	1
EP2401-0A	Needle Bar Thread Eyelet	1	ZSC09028	Screw (9/64-40×7)	2
EP2404-0A	Needle Bar	1			
EP2405-0A	Needle Bar Bracket	1			
EP2420-0A	Connecting Rod	1			
EP2420-0Z	Connecting Rod, Complete Set	1			
EP2422-0A	Seal Plug	1			
EP2424-0A	Connecting Rod Pin	1			
EP2427-0A	Needle Bar Guide	1			
EP2436-0A	Connecting Rod Cover Shaft	1			
EP2438-0A	Connecting Rod Cover (Rear)	1			
EP2440-0A	Connecting Rod Cover (Front)	1			
EP5429-0A	HR Device, Complete Set	1			
EP5430-0A	HR Container	1			
EP5431-0A	HR Container Lid	1			
EP5433-0A	HR Felt	1			
EP5434-0A	HR Felt Guard	1			
INUY128GAS	Needle	3			
WA080009	Connecting Rod Ring	1			
WD000035	Washer	1			
XA300025	Oil Wick	1			
ZMB03020	Screw (M3-0.5×5)	2			
ZMB04007	Screw (M4-0.7×5)	1			
ZMB04016	Screw (M4-0.7×10)	1			
ZMH04001	Screw (M4-0.7×4)	1			
ZMH08004	Screw (M8-1×16)	2			

J. PRESSER FOOT MECHANISM

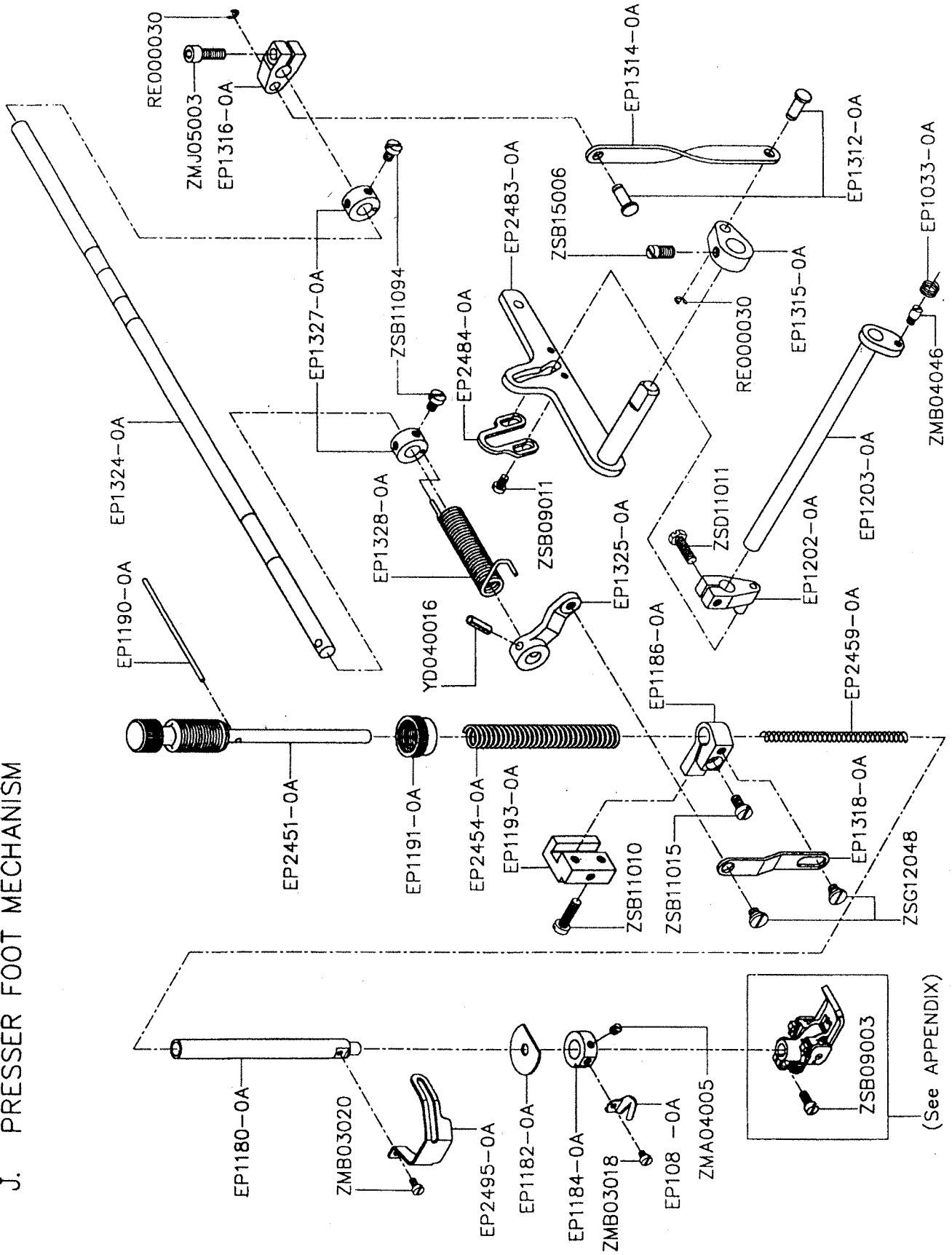

J. PRESSER FOOT MECHANISM

Parts No.	Name of Parts	Q'TY	Parts No.	Name of Parts	Q'TY
EP1033-0A	Swing-proof Spring	1	ZMB04046	Screw (M4-0.7×3.8)	1
EP1082-0A	Thread Chain Cutting Knife	1	ZMJ05003	Screw (M5-0.8×15)	1
EP1180-0A	Presser Bar	1	ZSB09003	Screw (9/64-40×10)	1
EP1182-0A	Oil Protector Ring	1	ZSB09011	Screw (9/64-40×5.6)	2
EP1184-0A	Collar	1	ZSB11010	Screw (11/64-40×16)	2
EP1186-0A	Presser Bar Connecting Bracket	1	ZSB11015	Screw (11/64-40×8.3)	1
EP1190-0A	Wire	1	ZSB11094	Screw (11/64-40×5.5)	4
EP1191-0A	Lock Nut	1	ZSB15006	Screw (15/64-28×9.5)	1
EP1193-0A	Presser Bar Guide	1	ZSD11011	Screw (11/64-40×14.5)	1
EP1202-0A	Tension Release Lever	1	ZSG12048	Screw (3/16-32×2.2)	2
EP1203-0A	Tension Release Shaft	1			
EP1312-0A	Connecting Pin	2			
EP1314-0A	Connecting Plate	1			
EP1315-0A	Lifter Lever (Small)	1			
EP1316-0A	Intermediate Lever	1			
EP1318-0A	Lifter Link	1			
EP1324-0A	Lifter Shaft	1			
EP1325-0A	Lifter Link Lever	1			
EP1327-0A	Collar	2			
EP1328-0A	Lifter Spring	1			
EP2451-0A	Presser Spring Regulator	1			
EP2454-0A	Presser Bar Spring (Outer)	1			
EP2459-0A	Presser Bar Spring (Inner)	1			
EP2483-0A	Lifter Lever	1			
EP2484-0A	Lifter Lever Stop	1			
EP2495-0A	Finger Guard	1			
RE000030	Retainer Ring	2			
YD040016	Fastener Pin	1			
ZMA04005	Screw (M4-0.7×4)	2			
ZMB03018	Screw (M3-0.5×3.5)	1			
ZMB03020	Screw (M3-0.5×5)	1			

K. SPREADER MECHANISM

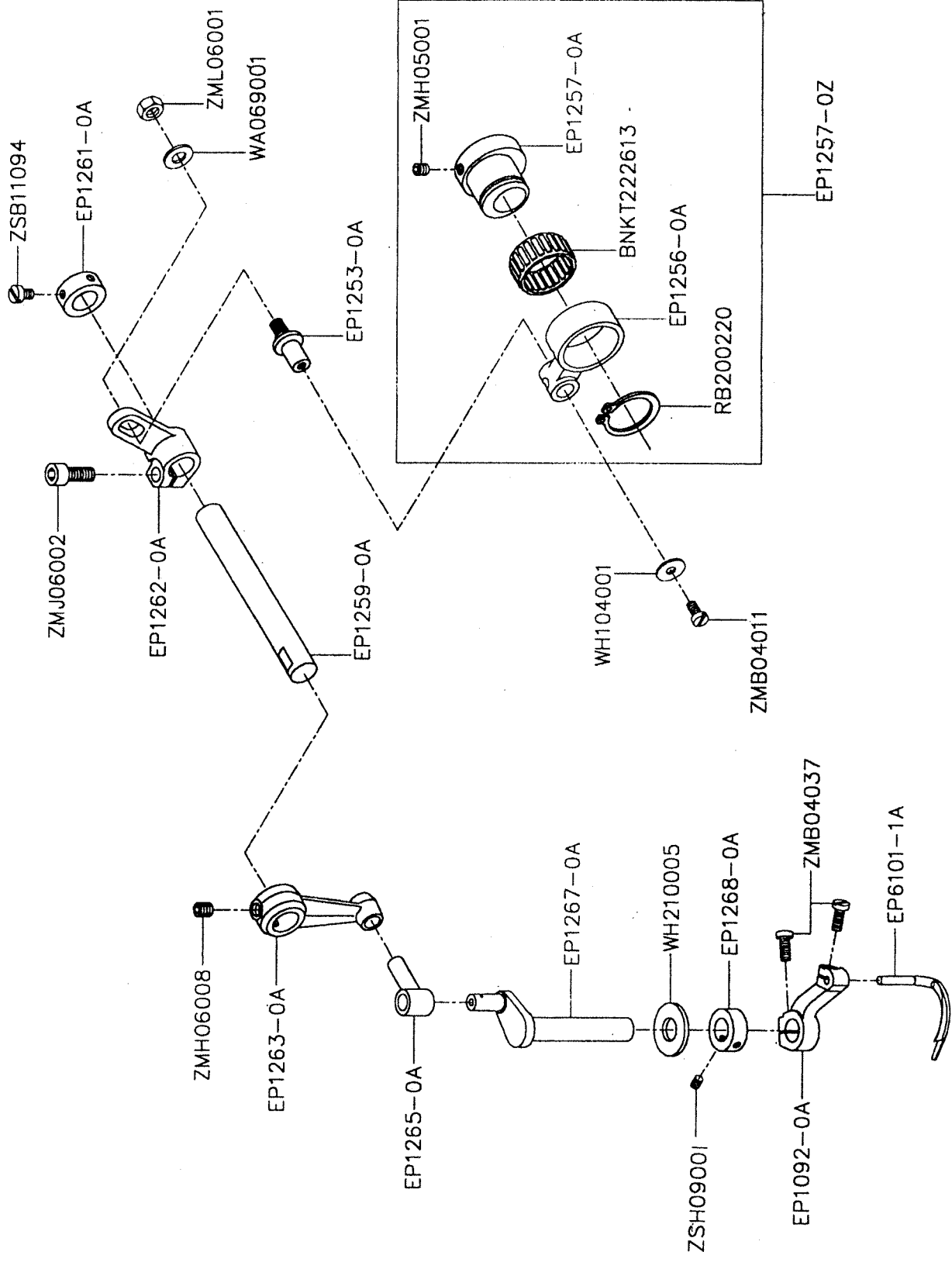

K. SPREADER MECHANISM

Parts No.	Name of Parts	Q'TY
BNKT222613	Roller Bearing	1
EP1092-0A	Spreader Holder	1
EP1253-0A	Adjusting Lever Pin	1
EP1256-0A	Connecting Rod	1
EP1257-0A	Eccentric	1
EP1257-0Z	Connecting Rod, Complete Set	1
EP1259-0A	Driving Shaft	1
EP1261-0A	Collar	1
EP1262-0A	Adjusting Lever	1
EP1263-0A	Rocking Arm	1
EP1265-0A	Rocking Pin	1
EP1267-0A	Spreader Bar	1
EP1268-0A	Collar	1
EP6101-1A	Spreader	1
RB200220	Retainer Ring	1
WA069001	Washer	1
WH104001	Washer	1
WH210005	Bushing Ring	1
ZMB04011	Screw (M4-0.7×8)	1
ZMB04037	Screw (M4-0.7×12)	2
ZMH05001	Screw (M5-0.8×5)	2
ZMH06008	Screw (M6-1×6)	2
ZMJ06002	Screw (M6-1×15)	1
ZML06001	Nut (M6-1)	1
ZSA09009	Screw (9/64-40×4.4)	2
ZSB11094	Screw (11/64-40×5.5)	2

L. LOOPER DRIVING MECHANISM(1)

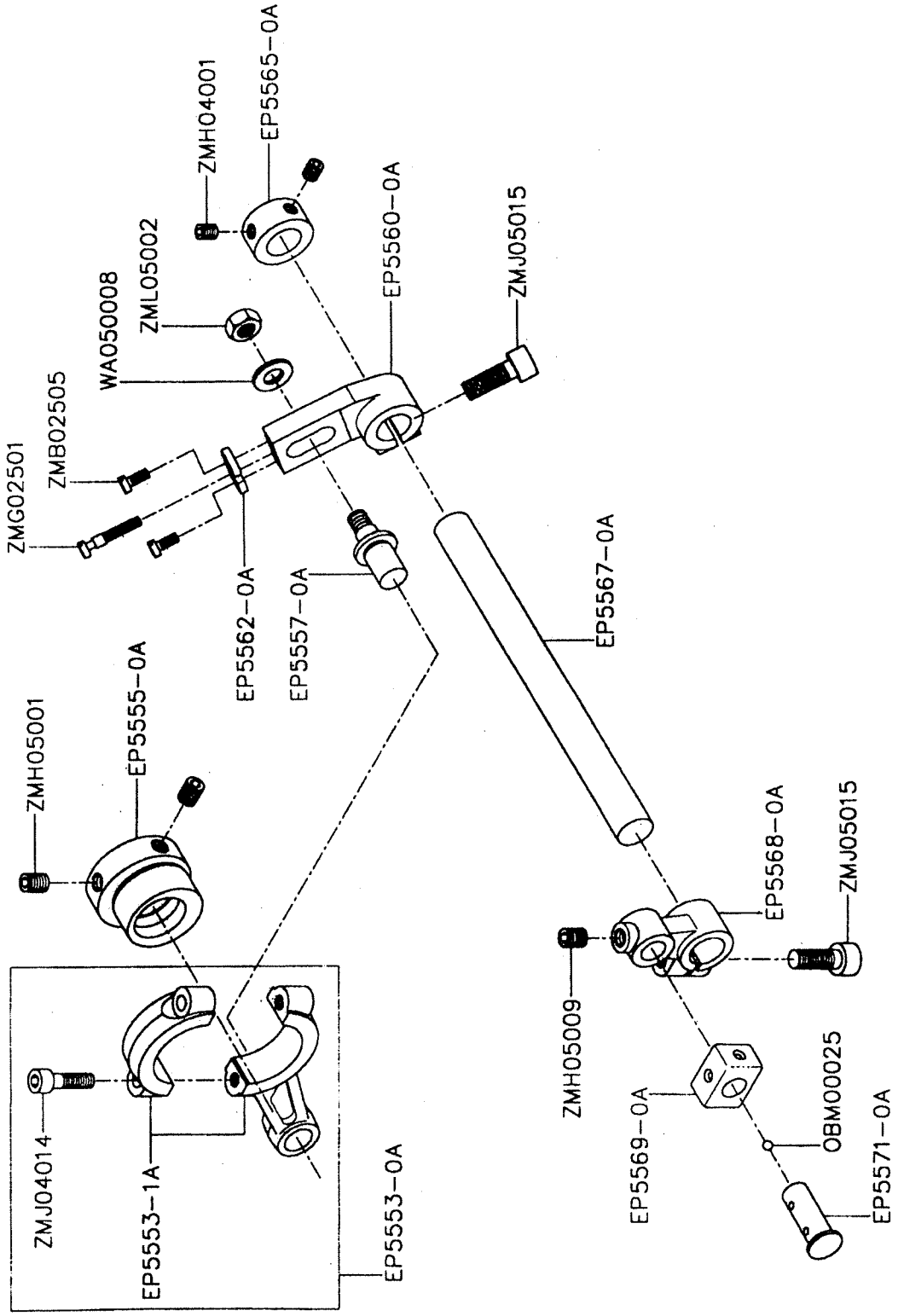

L. LOOPER DRIVING MECHANISM(1)

Parts No.	Name of Parts	Q'TY
EP5553-0A	Looper Rocker Connecting Rod ,C. Set	1
EP5553-1A	Looper Rocker Connecting Rod	1
EP5555-0A	Looper Rocker Eccentric	1
EP5557-0A	Connecting Rod Pin	1
EP5560-0A	Looper Rocker Lever	1
EP5562-0A	Looper Rocker Adjusting Guide Plate	1
EP5565-0A	Collar	1
EP5567-0A	Looper Rocker Shaft	1
EP5568-0A	Looper Rocker Arm	1
EP5569-0A	Looper Slide Block	1
EP5571-0A	Looper Slide Block Pin	1
OBM00025	Seal Plug	1
WA050008	Washer	1
ZMB02505	Screw (M2.5-0.45×6)	2
ZMG02501	Screw (M2.5-0.45×10.5)	1
ZMH04001	Screw (M4-0.7×4)	2
ZMH05001	Screw (M5-0.8×5)	2
ZMH05009	Screw (M5-0.8×5)	1
ZMJ04014	Screw (M4-0.7×14)	2
ZMJ05015	Screw (M5-0.8×14)	2
ZML05002	Nut (M5-0.8)	1

M. LOOPER DRIVING MECHANISM(2)

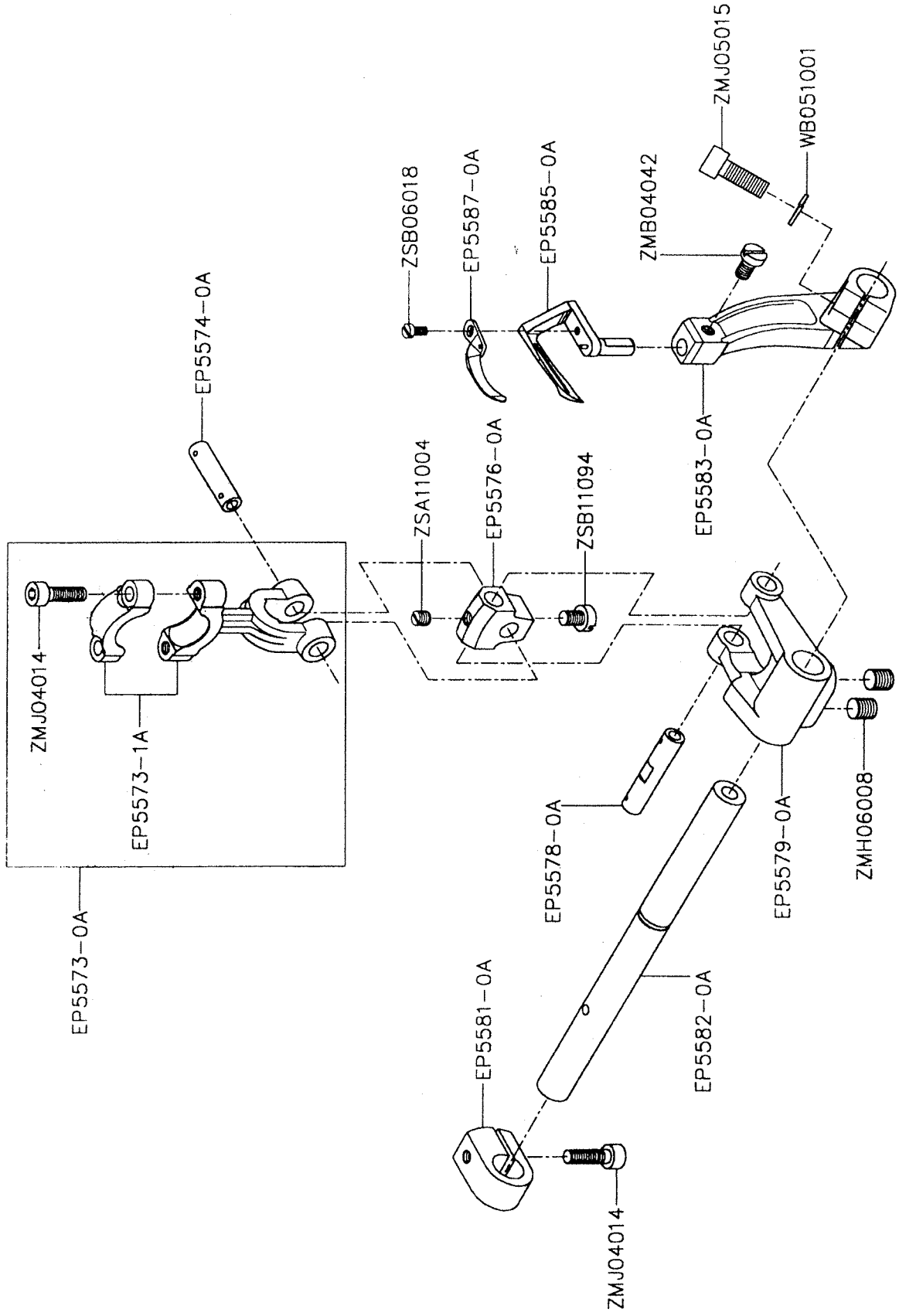

M. LOOPER DRIVING MECHANISM(2)

Parts No.	Name of Parts	Q'TY
EP5573-0A	Looper Connecting Rod, C. Set	1
EP5573-1A	Looper Connecting Rod	1
EP5574-0A	Link Pin (Short)	1
EP5576-0A	Looper Driving Lever Link	1
EP5578-0A	Link Pin (Long)	1
EP5579-0A	Looper Driving Lever	1
EP5581-0A	Collar	1
EP5582-0A	Looper Driving Shaft	1
EP5583-0A	Looper Holder	1
EP5585-0A	Looper	1
EP5587-0A	Needle Guard (Front)	1
WB051001	Spring Washer	1
ZMB04042	Screw (M4-0.7×7)	1
ZMH06008	Screw (M6-1×6)	2
ZMJ04014	Screw (M4-0.7×14)	3
ZMJ05015	Screw (M5-0.8×14)	1
ZSA11004	Screw (11/64-40×3.3)	1
ZSB06018	Screw (3/32-56×4.2)	1
ZSB11094	Screw (11/64-40×5.5)	1

N. FEED DRIVING CONTROL MECHANISM

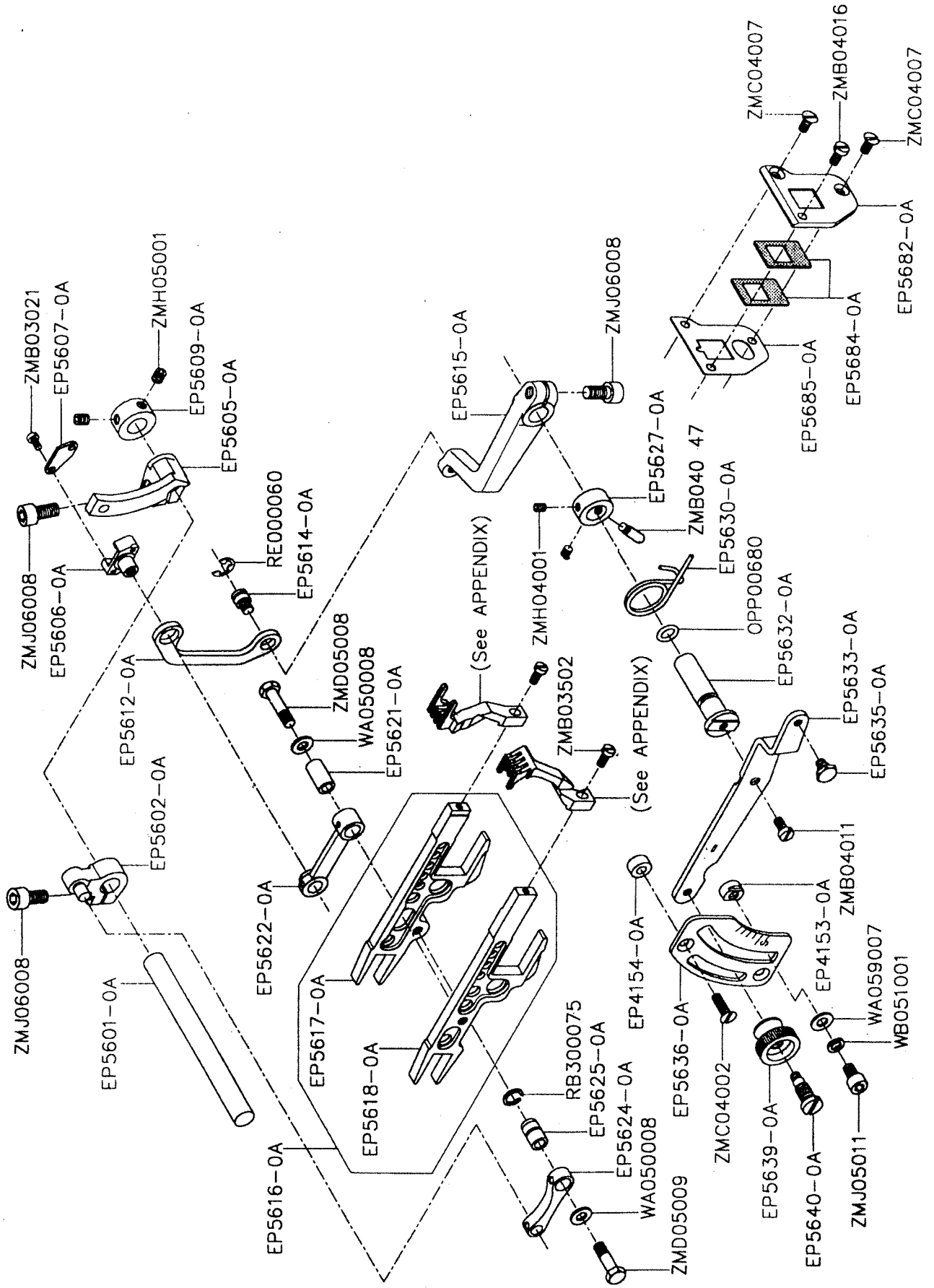

N. FEED DRIVING CONTROL MECHANISM

Parts No.	Name of Parts	Q'TY	Parts No.	Name of Parts	Q'TY
EP4153-0A	Control Lever Stop	2	RE000060	Retaining Ring	1
EP4154-0A	Spacer	2	WA050008	Washer	2
EP5601-0A	Feed Bar Driving Shaft	1	WA059007	Washer	2
EP5602-0A	Main Feed Bar Lever	1	WB051001	Spring Washer	2
EP5605-0A	Differential Rocker	1	ZMB03021	Screw (M3-0.5×6)	2
EP5606-0A	Differential Regulating Slider	1	ZMB03502	Screw (M3.5-0.6×8)	2
EP5607-0A	Differential Regulating Slider Cap	1	ZMB04011	Screw (M4-0.7×8)	1
EP5609-0A	Collar	1	ZMB04016	Screw (M4-0.7×8)	1
EP5612-0A	Slider Link	1	ZMB04047	Screw (M4-0.7×3.5)	1
EP5614-0A	Slider Link Pin	1	ZMC04002	Screw (M4-0.7×14)	2
EP5615-0A	Differential Lever (Inner)	1	ZMC04007	Screw (M4-0.7×7.3)	2
EP5616-0A	Feed Bar, C. Set	1	ZMD05008	Screw (M5-0.5×6)	1
EP5617-0A	Main Feed Bar	1	ZMD05009	Screw (M5-0.5×6)	1
EP5618-0A	Differential Feed Bar	1	ZMH04001	Screw (M4-0.7×4)	2
EP5621-0A	Connecting Bushing	1	ZMH05001	Screw (M5-0.8×5)	2
EP5622-0A	Differential Feed Bar Connector	1	ZMJ05011	Screw (M5-0.8×8)	2
EP5624-0A	Main Feed Bar Connector	1	ZMJ06008	Screw (M6-1×12)	3
EP5625-0A	Connector Bushing	1			
EP5627-0A	Collar	1			
EP5630-0A	Differential Lever Spring	1			
EP5632-0A	Differential Lever Shaft	1			
EP5633-0A	Differential Lever (Left)	1			
EP5635-0A	Screw (11/64-40×3.2)	1			
EP5636-0A	Differential Feed Graduation	1			
EP5639-0A	Adjusting Nut	1			
EP5640-0A	Adjusting Screw (1/4-40×11, 11/64-40×4)	1			
EP5682-0A	Feed Bar Shield Holder (Front)	1			
EP5684-0A	Feed Bar Shield	2			
EP5685-0A	Feed Bar Shield Holder (Rear)	1			
OPP00680	O-ring (P7)	1			
RB300075	Retaining Ring	1			

O. FEED DRIVING MECHANISM

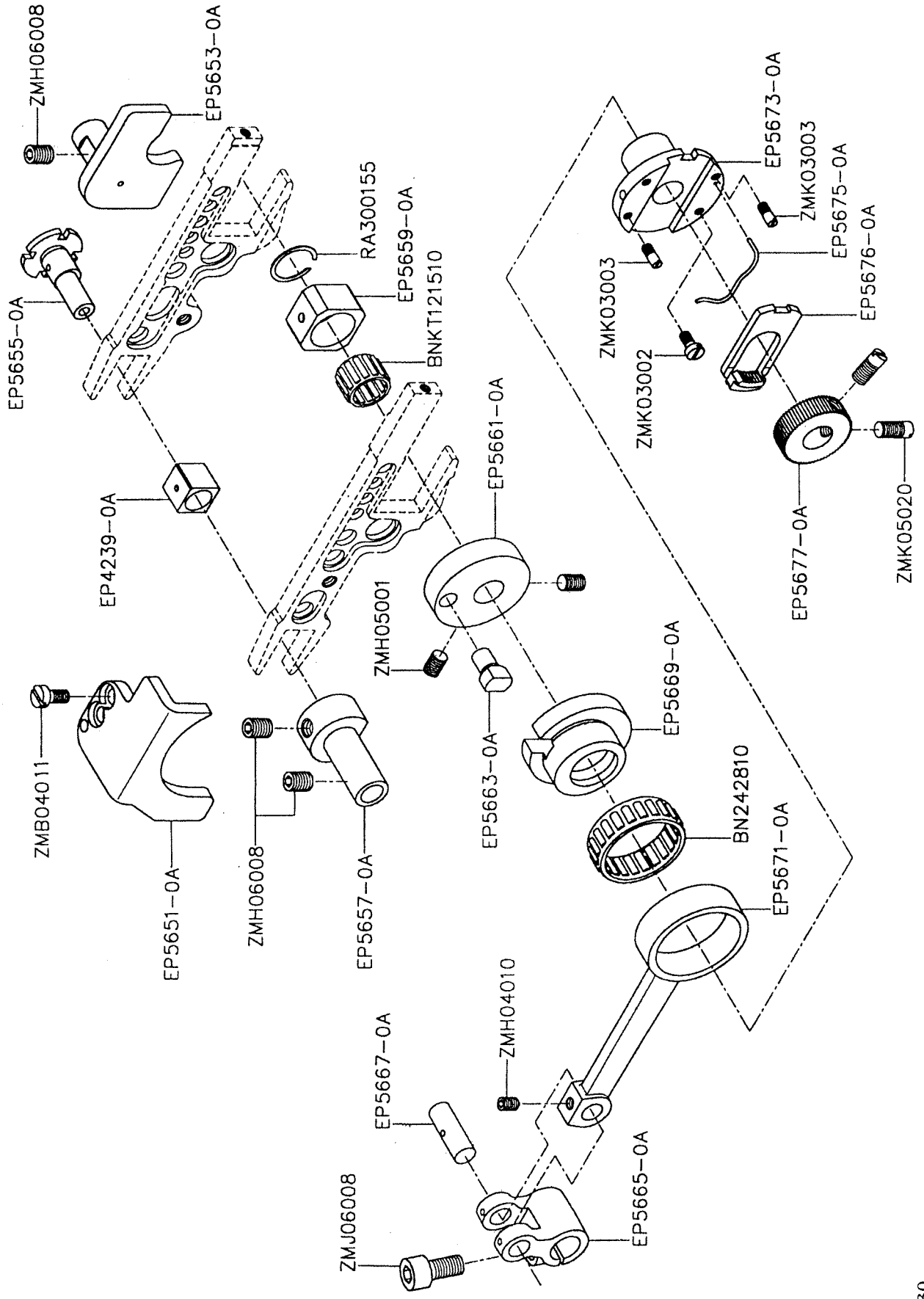

O. FEED DRIVING MECHANISM

Parts No.	Name of Parts	Q'TY
BN242810	Roller Bearing	1
BNKT121510	Roller Bearing	1
EP4239-0A	Feed Lift Block (Rear)	1
EP5651-0A	Feed Bar Guide (Left)	1
EP5653-0A	Feed Bar Guide (Right)	1
EP5655-0A	Feed Adjusting Pin	1
EP5657-0A	Feed Bar Guide (Rear)	1
EP5659-0A	Feed Bar Block (Front)	1
EP5661-0A	Eccentric Pin Holder	1
EP5663-0A	Feed Dog Eccentric Pin	1
EP5665-0A	Feed Bar Driving Shaft Lever	1
EP5667-0A	Connecting Rod Pin	1
EP5669-0A	Feed Dog Eccentric	1
EP5671-0A	Feed Dog Driving Connecting Rod	1
EP5673-0A	Feed Dog Regulating Eccentric	1
EP5675-0A	Feed Dog Regulating Plate Spring	1
EP5676-0A	Feed Dog Regulating Plate	1
EP5677-0A	Feed Dog Regulating Gear	1
RA300155	Retaining Ring	1
ZMH04010	Screw (M4-0.7×4.5)	1
ZMB04011	Screw (M4-0.7×8)	2
ZMH05001	Screw (M5-0.8×5)	2
ZMH06008	Screw (M6-1×6)	3
ZMJ06008	Screw (M6-1×12)	1
ZMK03002	Screw (M3-0.5×6)	1
ZMK03003	Screw (M3-0.5×4)	3
ZMK05020	Screw (M5-0.8×8)	2

P. LUBRICATING SYSTEM

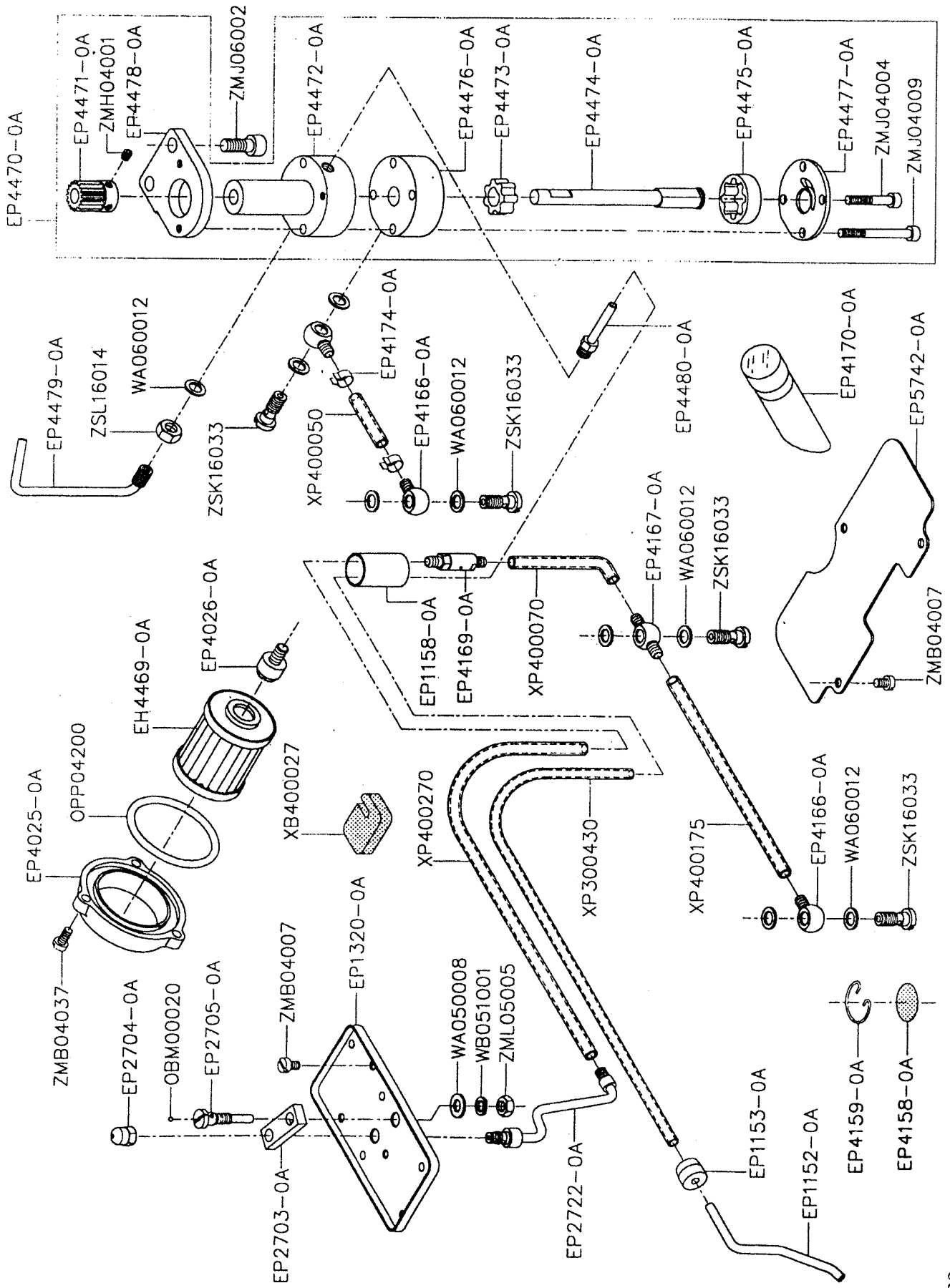

P. LUBRICATING SYSTEM

Parts No.	Name of Parts	Q'TY	Parts No.	Name of Parts	Q'TY
EH4469-0A	Oil Filter	1	OPP04200	O-ring(P42)	1
EP1152-0A	Suction Pipe	1	WA050008	Washer	1
EP1153-0A	Suction Pipe Bushing	1	WA060012	Washer	9
EP1158-0A	Draining Pipe	1	WB051001	Spring Washer	1
EP1320-0A	Oil Receiver	1	XB400027	Felt	1
EP2703-0A	Lubricant Guiding Block	1	XP300430	Oil Tube (3×5×430mm)	1
EP2704-0A	Top Nozzle Cap	1	XP400050	Oil Tube (4×6×50mm)	1
EP2705-0A	Oil Adjusting Screw	1	XP400070	Oil Tube (4×6×70mm)	1
EP2722-0A	Oil Pipe Unit	1	XP400175	Oil Tube (4×6×175mm)	1
EP4025-0A	Oil Filter Cap	1	XP400270	Oil Tube (4×6×270mm)	1
EP4026-0A	Oil Filter Connector	1	ZMB04007	Screw (M4-0.7×5)	5
EP4158-0A	Oil Filter Screen	1	ZMB04037	Screw (M4-0.7×12)	3
EP4159-0A	Oil Filter Screen Clamp	1	ZMH04001	Screw (M4-0.7×4)	2
EP4166-0A	Oil Tube Joint, One Way	3	ZMJ04004	Screw (M4-0.7×25)	2
EP4167-0A	Oil Tube Joint, Two Way	1	ZMJ04009	Screw (M4-0.7×40)	2
EP4169-0A	Non-return Valve Unit	1	ZMJ06002	Screw (M6-1×15)	2
EP4170-0A	Oil Lever Gauge	1	ZML05005	Nut	1
EP4174-0A	Oil Tube Clamp	2	ZSK16033	Fitting Stud (Short)	4
EP4470-0A	Oil Pump, Complete Set	1	ZSL16014	Nut	1
EP4471-0A	Oil Pump Driving Worm Gear	1			
EP4472-0A	Pump Housing	1			
EP4473-0A	Inner Gear	2			
EP4474-0A	Shaft	1			
EP4475-0A	Ring Gear	2			
EP4476-0A	Pump Base	1			
EP4477-0A	Pump Base Cover	1			
EP4478-0A	Pump Bracket	1			
EP4479-0A	Oil Nozzle for Worm Gear	1			
EP4480-0A	Suction Pipe	1			
EP5742-0A	Oil Nozzle for Worm Gear	1			
O5M00020	Seal Plug	1			

R. ACCESSORIES

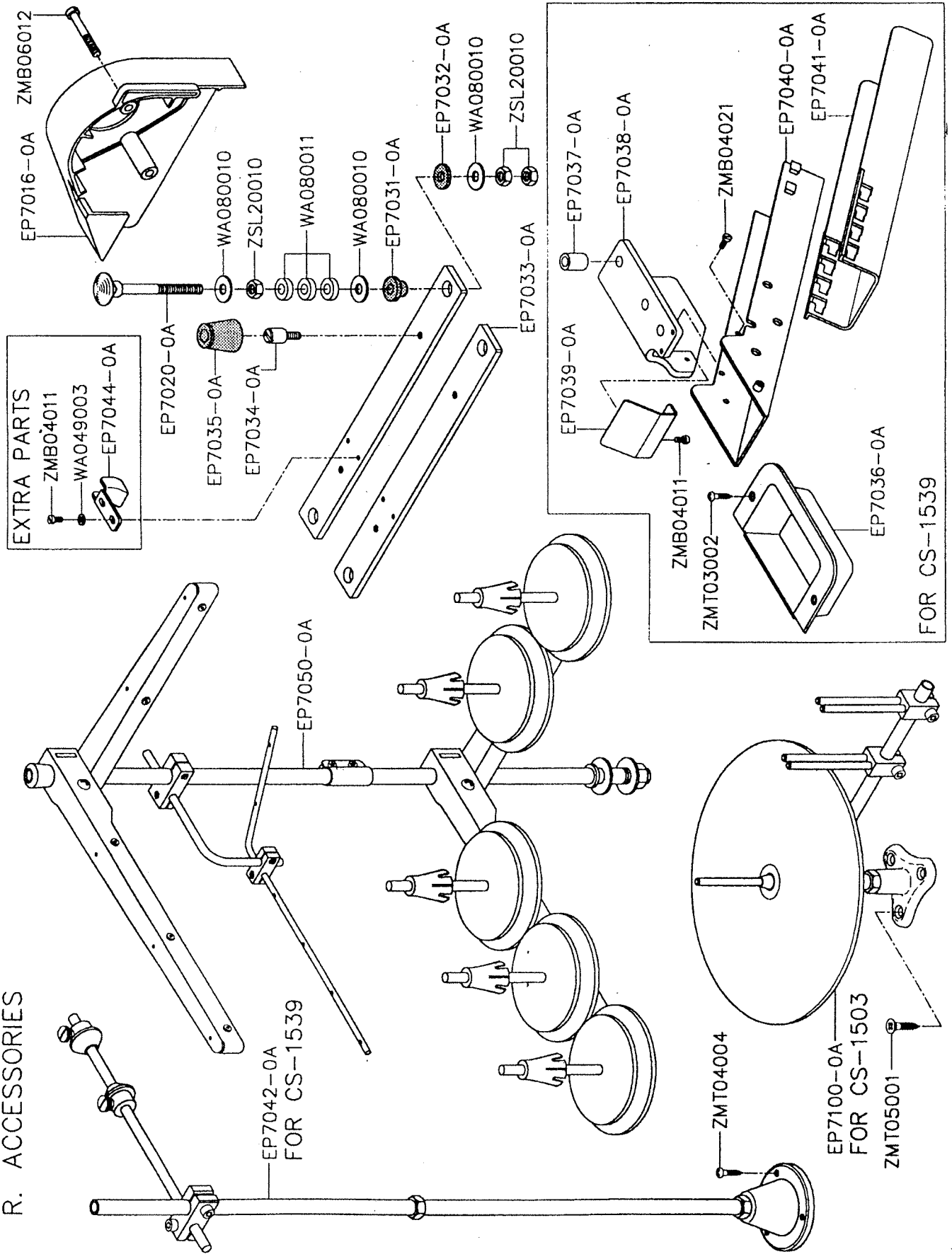

FOR CS-1539

R. ACCESSORIES

Parts No.	Name of Parts	Q'TY
EP7016-0A	Belt Cover	1
EP7020-0A	Hanging Bolt (UNC5/16-18×95)	4
EP7031-0A	Supporting Board Rubber Cushion	4
EP7032-0A	Supporting Board Rubber Cushion (Lower)	4
EP7033-0A	Supporting Board	2
EP7034-0A	Setting Screw	4
EP7035-0A	Oil Reservoir Rubber Cushion	4
EP7036-0A	Chip Receiver	1
EP7037-0A	Spacer	2
EP7038-0A	Chute Support	1
EP7039-0A	Chip Guiding Plate	1
EP7040-0A	Chute (Upper)	1
EP7041-0A	Chute (Lower)	1
EP7042-0A	Elastic Tap Stand, Complete Set	1
EP7044-0A	Chain Guide	1
EP7050-0A	Thread Stand, Complete Set	1
EP7100-0A	Knitted Tap Stand, Complete Set	1
WA049003	Washer	2
WA080010	Washer	12
WA080011	Washer	12
ZMB04011	Screw (M4-0.7×8)	4
ZMB04021	Screw (M4-0.7×10)	2
ZMB06012	Screw (M6-1×46)	2
ZMT03002	Wood Screw	2
ZMT04004	Wood Screw	3
ZMT05001	Wood Screw	3
ZSL20010	Nut (UNC5/16-18)	12

NUMERICAL PARTS-LIST (1/4)

PARTS NO.	PAGE	PARTS NO.	PAGE	PARTS NO.	PAGE	PARTS NO.	PAGE	PARTS NO.	PAGE	PARTS NO.	PAGE
A1015-0B	2	EP1016-1A	2	EP1057-0A	6	EP1152-0A	32	EP1271-0A	14		
A1015-1A	2	EP1018-0A	2	EP1058-0A	6	EP1153-0A	32	EP1273-0A	14		
A1019-0A	2	EP1021-0A	6	EP1059-0A	6	EP1158-0A	32	EP1275-0A	16		
A7001-0A	34	EP1021-1A	6	EP1060-0A	6	EP1179-0A	8	EP1276-0A	16		
A7010-0A	34	EP1021-2A	6	EP1061-0A	6	EP1180-0A	20	EP1278-0A	16		
A7010-1A	34	EP1024-0A	6	EP1062-0A	6	EP1182-0A	20	EP1279-0A	16		
A7010-2A	34	EP1024-1A	6	EP1063-0A	6	EP1184-0A	20	EP1279-1A	16		
A7012-1A	34	EP1025-0A	6	EP1064-0A	6	EP1186-0A	20	EP1281-0A	8		
B7060-0A	34	EP1026-0A	6	EP1067-0A	6	EP1190-0A	20	EP1282-0A	8		
BB6002	10	EP1027-0A	6	EP1068-0A	16	EP1191-0A	20	EP1283-0A	14		
BB6004ZZNR	10	EP1029-0A	6	EP1069-0A	16	EP1193-0A	20	EP1301-0A	8		
BB6202VV	14	EP1030-0A	6	EP1072-0A	16	EP1202-0A	20	EP1312-0A	20		
BB6204VVNR	10,14	EP1031-0A	6	EP1073-0A	6	EP1203-0A	20	EP1314-0A	20		
BB6205VVNR	10	EP1032-0A	6	EP1076-0A	18	EP1253-0A	22	EP1315-0A	20		
BB6300VV	10	EP1033-0A	20	EP1077-0A	2, 4, 8, 18	EP1254-0A	8	EP1316-0A	20		
BN242810	30	EP1034-0A	6	EP1082-0A	20	EP1255-0A	8	EP1318-0A	20		
BNKT121510	30	EP1035-0A	6,12	EP1083-0A	18	EP1256-0A	22	EP1320-0A	32		
BNKT222613	22	EP1036-0A	6,12	EP1084-0A	8	EP1257-0A	22	EP1324-0A	20		
BNKT81113	18	EP1037-0A	6,12	EP1085-0A	8	EP1257-0Z	22	EP1325-0A	20		
EH4469-0A	32	EP1038-0A	6	EP1086-0A	8	EP1259-0A	22	EP1327-0A	20		
EH7012-0A	34	EP1039-1A	6	EP1087-0A	8	EP1261-0A	22	EP1328-0A	20		
EP1009-0A	4	EP1041-0A	6	EP1092-0A	14	EP1262-0A	22	EP1345-0A	14		
EP1010-0A	4	EP1042-0A	6	EP1100-1A	14	EP1263-0A	22	EP1346-0A	14		
EP1011-0A	4	EP1043-0A	6	EP1100-1Z	16	EP1265-0A	22	EP1347-0A	10		
EP1012-0A	4	EP1045-0A	6	EP1103-0A	10, 14	EP1267-0A	22	EP1360-0A	2		
EP1014-0A	4	EP1047-0A	6	EP1105-1A	14	EP1268-0A	22	EP1361-0A	2		
EP1015-0A	2	EP1051-0A	6	EP1106-0A	18	EP1269-0A	8	EP1362-0A	2		
EP1015-1A	14	EP1056-0A	6	EP1130-0A	18	EP1270-0A	8	EP1364-0A	2		

NUMERICAL PARTS-LIST (2/4)

PARTS NO.	PAGE	PARTS NO.	PAGE	PARTS NO.	PAGE	PARTS NO.	PAGE	PARTS NO.	PAGE	PARTS NO.	PAGE
EP1367-0A	4, 8	EP4026-0A	32	EP5118-0A	2	EP5183-2A	4	EP5323-0A	10		
EP1368-0A	4	EP4068-0A	2	EP5119-0A	2, 4	EP5189-0A	4	EP5324-0A	10		
EP1500-10	2	EP4153-0A	28	EP5120-0A	2	EP5193-0A	4	EP5327-0A	10		
EP2251-0A	8	EP4154-0A	28	EP5123-0A	2	EP5215-0A	6	EP5329-0A	10		
EP2253-0A	8	EP4158-0A	32	EP5130-0A	2	EP5218-0A	6, 12	EP5335-0A	12		
EP2254-0A	8	EP4159-0A	32	EP5133-0A	2	EP5283-0A	8	EP5336-0A	12		
EP2401-0A	18	EP4166-0A	32	EP5134-0A	2	EP5285-0A	8	EP5337-0A	12		
EP2404-0A	18	EP4167-0A	32	EP5137-0A	2	EP5286-0A	8	EP5339-0A	12		
EP2405-0A	18	EP4169-0A	32	EP5142-0A	4	EP5288-0A	8	EP5341-0A	12		
EP2420-0A	18	EP4170-0A	32	EP5144-0A	4	EP5269-0A	8	EP5343-0A	12		
EP2420-0Z	18	EP4174-0A	32	EP5144-1A	4	EP5270-0A	8	EP5346-0A	12		
EP2422-0A	18	EP4203-0A	4	EP5147-0A	4	EP5271-0A	8	EP5354-0A	12		
EP2424-0A	18	EP4239-0A	30	EP5149-0A	4	EP5272-0A	8	EP5356-0A	12		
EP2427-0A	18	EP4288-0A	2	EP5155-0A	4	EP5274-0A	8	EP5369-0A	14		
EP2436-0A	18	EP4470-0A	32	EP5156-0A	4	EP5275-0A	8	EP5396-0A	14		
EP2438-0A	18	EP4471-0A	32	EP5159-0A	4	EP5276-0A	8	EP5429-0A	18		
EP2440-0A	18	EP4472-0A	32	EP5160-0A	4	EP5279-0A	8	EP5430-0A	18		
EP2451-0A	20	EP4473-0A	32	EP5161-0A	4	EP5280-0A	8	EP5431-0A	18		
EP2454-0A	20	EP4474-0A	32	EP5162-0A	4	EP5292-0A	8	EP5433-0A	18		
EP2459-0A	20	EP4475-0A	32	EP5169-0A	4	EP5301-0A	10	EP5434-0A	18		
EP2483-0A	20	EP4476-0A	32	EP5170-0A	4	EP5305-0A	10	EP5553-0A	24		
EP2484-0A	20	EP4477-0A	32	EP5171-0A	4	EP5309-0A	10	EP5553-1A	24		
EP2495-0A	20	EP4478-0A	32	EP5172-0A	4	EP5312-0A	10	EP5555-0A	24		
EP2703-0A	32	EP4479-0A	32	EP5174-0A	4	EP5313-0A	10	EP5557-0A	24		
EP2704-0A	32	EP4480-0A	32	EP5176-0A	4	EP5314-0A	10	EP5560-0A	24		
EP2705-0A	32	EP5111-0A	2	EP5179-0A	4	EP5319-0A	10	EP5562-0A	24		
EP2722-0A	32	EP5112-0A	2	EP5180-0A	4	EP5319-1A	10	EP5565-0A	24, 28		
EP4025-0A	32	EP5113-0A	2	EP5183-0A	4	EP5321-0A	10	EP5567-0A	24		

NUMERICAL PARTS-LIST (3/4)



PARTS NO.	PAGE	PARTS NO.	PAGE	PARTS NO.	PAGE	PARTS NO.	PAGE	PARTS NO.	PAGE	PARTS NO.	PAGE
EP5568-0A	24	EP5624-0A	28	EP6101-1A	22	OPP00680	28	WA080011	28	WA080011	34
EP5569-0A	24	EP5625-0A	28	EP7016-0A	34	OPP04200	34	WB051001	32	WB051001	16, 26, 28, 32
EP5571-0A	24	EP5630-0A	28	EP7020-0A	34	RA300155	34	WC059001	30	WC059001	2, 4
EP5573-0A	26	EP5632-0A	28	EP7031-0A	34	RB20015B	34	WC060003	14	WC060003	4, 8
EP5573-1A	26	EP5633-0A	28	EP7032-0A	34	RB200220	34	WD000035	22	WD000035	18
EP5574-0A	26	EP5635-0A	28	EP7033-0A	34	RB300075	34	WH104001	28	WH104001	22
EP5576-0A	26	EP5636-0A	28	EP7034-0A	34	RE000030	34	WH205003	20	WH205003	16
EP5578-0A	26	EP5639-0A	28	EP7035-0A	34	RE000040	34	WH208007	6	WH208007	12
EP5579-0A	26	EP5640-0A	28	EP7036-0A	34	RE000060	34	WH209004	12, 28	WH209004	16
EP5581-0A	26	EP5651-0A	30	EP7037-0A	34	TLA015	34	WH210005	34	WH210005	22
EP5582-0A	26	EP5653-0A	30	EP7038-0A	34	TLA025	34	XA300180	34	XA300180	14
EP5583-0A	26	EP5655-0A	30	EP7039-0A	34	TLA030	34	XA300020	34	XA300020	8
EP5585-0A	26	EP5657-0A	30	EP7040-0A	34	TRB06X07	34	XA300025	34	XA300025	18
EP5587-0A	26	EP5659-0A	30	EP7041-0A	34	TRB08X10	34	XA300140	34	XA300140	10
EP5601-0A	28	EP5661-0A	30	EP7042-0A	34	WA030006	34	XB123001	6	XB123001	6
EP5602-0A	28	EP5663-0A	30	EP7044-0A	34	WA030007	34	XB310005	12	XB310005	6
EP5605-0A	28	EP5665-0A	30	EP7050-0A	34	WA039001	34	XB400027	12	XB400027	32
EP5606-0A	28	EP5667-0A	30	EP7086-0A	34	WA049003	34	XC200060	34	XC200060	6
EP5607-0A	28	EP5669-0A	30	EP7100-0A	34	WA049006	34	XP300430	6	XP300430	32
EP5609-0A	28	EP5671-0A	30	G7014-0A	34	WA050008	34	XP400050	24, 28, 32	XP400050	32
EP5612-0A	28	EP5673-0A	30	INUY128GAS	18, 34	WA050010	18, 34	XP400070	4	XP400070	32
EP5614-0A	28	EP5675-0A	30	L7070-0A	34	WA059005	34	XP400175	16	XP400175	32
EP5615-0A	28	EP5676-0A	30	OAGM081503	8	WA059007	8	XP400270	42	XP400270	32
EP5616-0A	28	EP5677-0A	30	OAGM101703	8	WA060012	8	YA050100	32	YA050100	4
EP5617-0A	28	EP5682-0A	28	OAVC153206	8	WA060017	8	YD020006	4	YD020006	6
EP5618-0A	28	EP5684-0A	28	OBM00020	32	WA069001	32	YD030010	22	YD030010	10
EP5621-0A	28	EP5685-0A	28	OBM00025	24	WA080009	24	YD040008	18	YD040008	6
EP5622-0A	28	EP5742-0A	32	OPP00600	4	WA080010	4	YD040016	34	YD040016	20, 28

NUMERICAL PARTS-LIST (4/4)

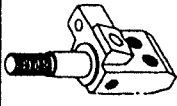
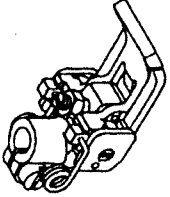
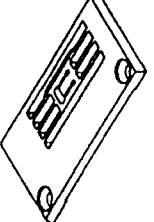
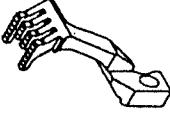

PARTS NO.	PAGE	PARTS NO.	PAGE	PARTS NO.	PAGE	PARTS NO.	PAGE
ZMA04005	20	ZMD05008	28	ZMJ05015	24, 26	ZSB09003	20
ZMB02505	24	ZMD05009	28	ZMJ05016	18	ZSB09011	18, 20
ZMB03018	20	ZMG02501	24	ZMJ06002	16, 22, 32	ZSB09017	6
ZMB03020	18, 20	ZMG04024	2	ZMJ06004	2	ZSB09030	12
ZMB03021	10, 28	ZMG04026	4	ZMJ06008	28, 30	ZSB09051	16
ZMB03023	4	ZMH03002	2, 10, 12	ZMK03002	30	ZSB11002	16
ZMB03502	16, 28	ZMH04001	4, 10, 18, 24	ZMK03003	30	ZSB11010	20
ZMB03503	10	ZMH04001	28, 32	ZMK04015	2, 4	ZSB11015	20
ZMB03507	12	ZMH04010	30	ZMK04016	4	ZSB11094	20, 22, 26
ZMB04007	2, 4, 18, 32	ZMH05001	10, 22, 24, 28	ZMK04017	2	ZSBI5006	20
ZMB04009	14	ZMH05001	30	ZMK05020	30	ZSB24002	2
ZMB04011	2, 4, 6, 12	ZMH05009	24	ZML04006	2	ZSC09028	18
ZMB04011	14, 22, 28, 30	ZMH06003	14	ZML05002	24	ZSD09002	12
ZMB04011	34	ZMH06008	10, 14, 22, 26	ZML05005	32	ZSD11011	20
ZMB04016	4, 12, 18, 28	ZMH06008	30	ZML06001	22	ZSG08006	6
ZMB04021	34	ZMH06011	10, 14	ZMQ06001	8	ZSG11060	8
ZMB04022	2, 4	ZMH06015	14	ZMT03002	34	ZSG11068	4
ZMB04037	2, 22, 32	ZMH08004	18	ZMT04004	34	ZSG12048	20
ZMB04042	26	ZMJ04002	4	ZMT05001	34	ZSK16033	32
ZMB04046	20	ZMJ04004	32	ZSA08009	18	ZSL11004	8
ZMB05021	4	ZMJ04009	32	ZSA09009	22	ZSL16014	32
ZMB06012	34	ZMJ04012	4, 18	ZSA11004	26	ZSL20010	34
ZMC03004	6, 12	ZMJ04013	18	ZSA14006	10	ZSN11002	6, 12
ZMC04002	28	ZMJ04014	24, 26	ZSB06013	8		
ZMC04003	4	ZMJ05001	10, 16	ZSB06017	18		
ZMC04005	4	ZMJ05003	20	ZSB06018	26		
ZMC04007	4, 6, 28	ZMJ05008	16	ZSB08038	16		
ZMD04004	4	ZMJ05011	28	ZSB08042	12		

Consew Models 697VF & 697BVF - APPENDIX

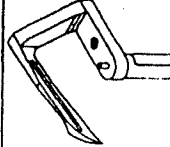
Alternative Parts for 2 Needles

Parts Name							
Models		Needle Clamp	Presser Foot	Stitch Plate	Differential Feed Dog	Main Feed Dog	Looper
697VF-2-132M		EP1075-232A	EP1231-232A	EP6050-232A	EP6061-310A	EP6062-310A	EP5585-0A
697VF-2-140M		EP1075-240A	EP1231-240A	EP6050-240A	EP6061-310A	EP6062-310A	EP5585-0A
697VF-2-148M		EP1075-248A	EP1231-248A	EP6050-248A	EP6061-310A	EP6062-310A	EP5585-0A

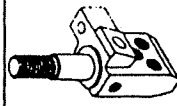
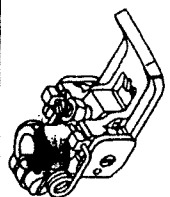
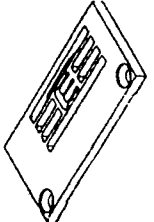
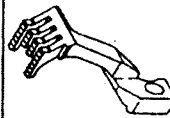
Alternative Parts for 3 Needles

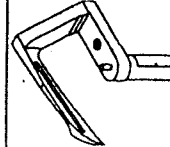
Parts Name							
Models		Needle Clamp	Presser Foot	Stitch Plate	Differential Feed Dog	Main Feed Dog	Looper
697VF-3-148M		EP1075-348A	EP1231-348A	EP6050-348A	EP6061-310A	EP6062-310A	EP5585-0A
697VF-3-156M		EP1075-356A	EP1231-356A	EP6050-356A	EP6061-310A	EP6062-310A	EP5585-0A
697VF-3-164M		EP1075-364A	EP1231-364A	EP6050-364A	EP6061-320A	EP6062-320A	EP5585-0A

inside of cover

Instruction Book for Models 697VF / 697BVF

Since 1898
CONSEW®

CONSOLIDATED SEWING MACHINE CORP.

— INDUSTRIAL SEWING & CUTTING EQUIPMENT

Main Office

131 West 25th Street
New York, NY 10001
Tel: 212-741-7788
Fax: 212-741-7787

Miami Branch Office

7855 N.W. 29th St. (#166)
Miami, FL 33122
Tel: 305-471-0200
Fax: 305-471-0243

West Coast Branch Office

1400 South Broadway
Los Angeles, CA 90015
Tel: 213-745-8844
Fax: 213-745-8855

e-mail: consew@worldnet.att.net

web: www.consew.com